

The World of Roof Technology

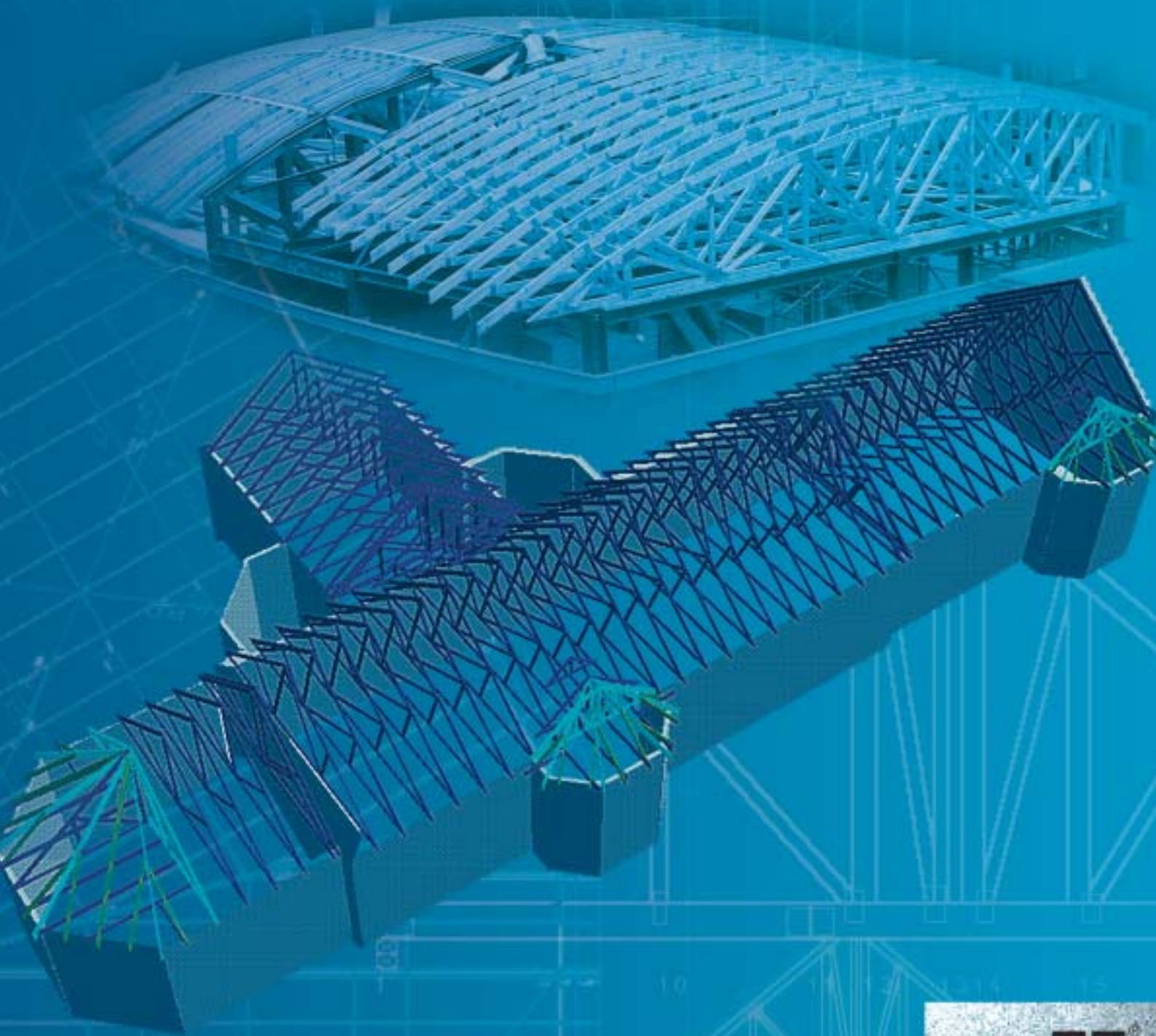

MII
MiTek®

Low Cost Estimation

• 100% Accuracy
• 100% Speed
• 100% Reliability
• 100% Satisfaction



How to use this Manual

This manual is provided to give information about the use of trussed rafters for roof construction and is intended to be of interest to Trussed Rafter Specifiers, Trussed Rafter Designers and Contractors using Trussed Rafters.

The manual is arranged in three sections:

SECTION 1	Information for specifiers
SECTION 2	Technical information
SECTION 3	Information for site use

Trussed rafters are now used for the overwhelming majority of domestic roofs constructed in the UK and Eire, and have an exceptional performance record since their introduction to the Building and Construction Industries.

A nationwide network of Authorised Trussed Rafter Fabricators can provide a competitive, economic solution to even the most complex of your roofing needs. Using the MiTek Engineering Design System, these companies provide high quality, purpose engineered units to satisfy the need of an ever more complex market.

We are confident that this document will demonstrate the advantages to you in selection and building successfully with trussed rafters.

SECTION 1

Information For Specifiers

- 1.1 What is a trussed rafter?
- 1.2 Design responsibilities
- 1.3 Exchange of information
- 1.4 Limits of use for trussed rafters
- 1.5 Basic Design principles
- 1.6 Guide to setting out and dimensioning
- 1.7 Practical roof solutions
- 1.8 Glossary of terms used

SECTION 2

Technical Information

- 2.1 Codes and standards
- 2.2 Timber
- 2.3 Connector plates
- 2.4 Design method
- 2.5 Roof and trussed rafter bracing
- 2.6 Loading and load cases
- 2.7 Selecting trussed rafter profiles
- 2.8 Framing common roof shapes
- 2.9 Connection details
- 2.10 Problems to be aware of

SECTION 3

Information for Site Use

- 3.1 Do's and Dont's on site
- 3.2 Supporting water tanks
- 3.3 Hatch and chimney openings
- 3.4 Two-Tier construction
- 3.5 Hip ends and corners
- 3.6 Valley intersections
- 3.7 Bracing trussed rafters and roofs
- 3.8 Loose timber connection details
- 3.9 Bearing details
- 3.10 Ventilation and condensation
- 3.11 Site storage and handling
- 3.12 Erection procedures
- 3.13 Risk assessments & method statements
- 3.14 Construction check list
- 3.15 Nailing and bolting
- 3.16 Attic Frames-2 & 3 part construction
- 3.17 Attic Frames-bracing
- 3.18 Attic Frames-environment
- 3.19 General construction details
- 3.20 Builders metalwork

What is a Trussed Rafter?

Trussed rafters or roof trusses are now specified for the majority of domestic roofs constructed in the UK and Eire. The trussed rafter is an individually designed component, engineered to provide a structural frame for the support of roof or similar structures.

Pre-fabricated from high quality, stress graded timbers and joined with steel nailplate fasteners, the trussed rafter offers:

A flexible, practical and fully engineered solution to your roofing requirements.

Economy of materials, as trussed rafters can use up to 40% less timber than a traditionally formed roof.

Reduced labour costs on site, due to the amount of pre-fabrications, releasing site joiners for more complex areas.

Quick erection of the roof structure enabling other trades to commence quickly.

Reduction in site waste, loss and pilferage of valuable materials.

Space saving on site, with no need for timber storage or carpentry work areas.

Competitive pricing from a nationwide network of Authorised Trussed Rafter Fabricators.

How to Specify Trussed Rafters

MiTek trussed rafters are available from a nationwide network of Authorised Fabricators. A full list of these companies is available on request from MiTek.

Please note that, unless a specific contract exists to the contrary, the Fabricators liability is limited to the design and supply of the individual trussed rafter components only. The responsibility for the design of the roof structure as a whole lies with the Building Designer (or Roof Designer if one has been appointed). Please refer to section 1.2 on Design Responsibility. There are, however, companies within the network of Authorised Fabricators that have the necessary experience and resources to undertake design responsibility for the roof structure as a whole.

To obtain competitive quotations for the design and supply of trussed rafters, contact one or more of the authorised Fabricators. They will be pleased to assist you in assessing your requirements.

The Fabricator will require sufficient, clear information regarding the roof structure to determine the required trussed rafter profiles, dimensions, spacings, quantities, loadings, methods of support and any special features to be taken into account; together with the requirements for timber treatment, extra items required (eg Builders metalwork), delivery date and delivery address. A check-list of the information required, together with a list of the information to be provided by the Fabricator to you, follows later in section 1.2.

Using the MiTek Design system, the required trusses will be designed for your individual application and the Fabricator will provide you with the details required to support the quotation.

If the quotation is successful, and subject to all dimensions being checked prior to the manufacture of the units, your trussed rafters will be supplied to site ready for speedy erection of the roof support structure.

The Project Steps

To illustrate the line of action for a project where trussed rafters are to be used, the following diagram may be of assistance:

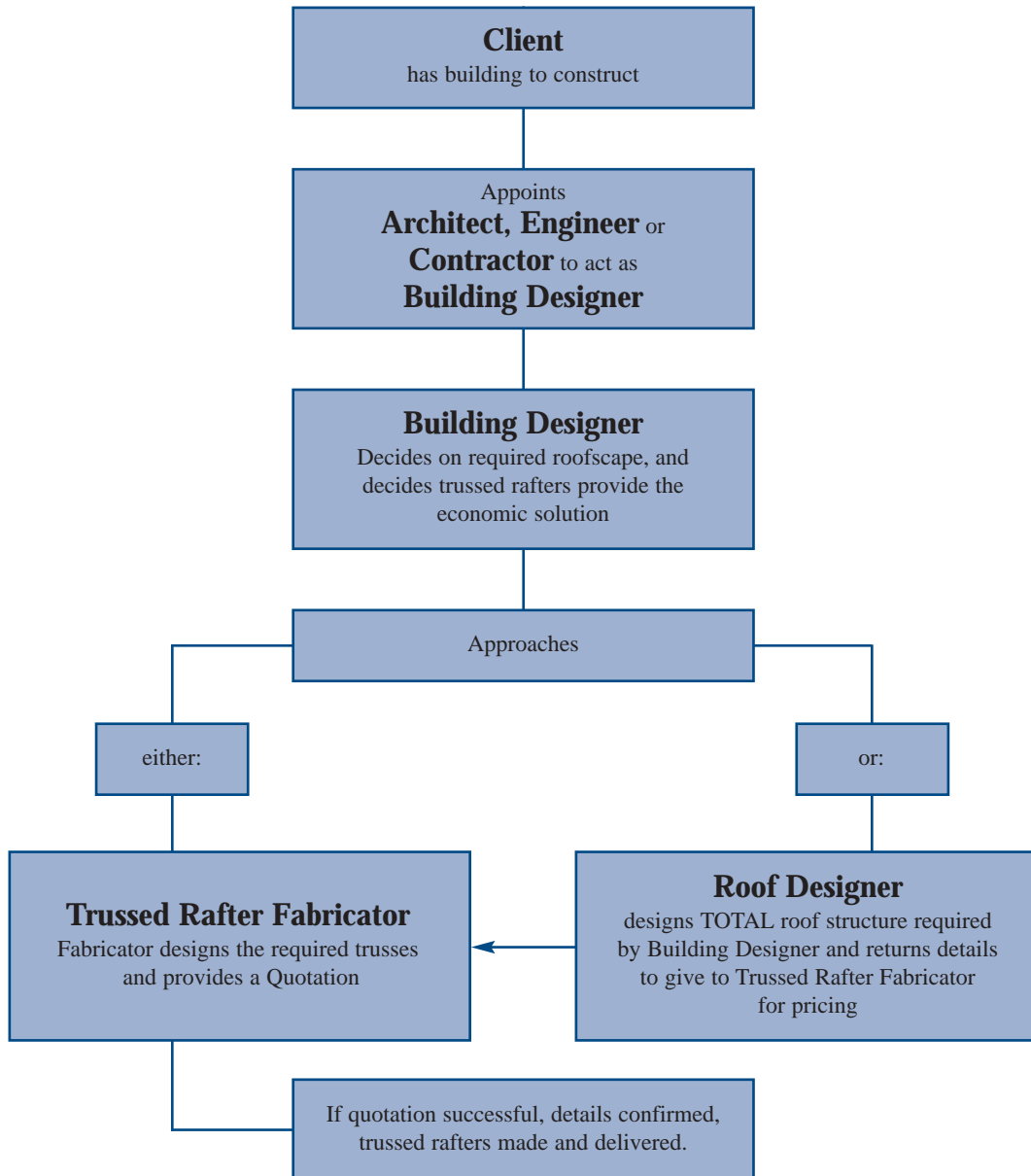

Notes:

On specific projects, the building designer may also encompass the function of Roof designer. This will generally be the case for small projects, where often, the Builder or his Architect will be the only professional people involved.

It is also possible for the roles of the Roof designer and the Trussed Rafter Fabricator to be combined, in the case where, by specific contract, the fabricator takes the responsibilities for the design of the whole or part of the roof structure. This arrangement will however be generally undertaken by the Fabricator on a professional, fee-paying basis.

Design Responsibilities

The areas of Design Responsibility for the roof structure of a building are as follows:-

1. Trussed Rafter Designer

The Trussed Rafter Designer is responsible for the design of trussed rafters as individual components.

He or she must ensure the structural integrity of the trussed rafter units and inform the Roof Designer (or

Building Designer where there is no specifically appointed Roof Designer), of any stability requirements needed in the design of the trussed rafters.

2. Roof Designer

If the Building Designer has appointed a Roof Designer, they are responsible for the design of the roof structure as a whole and must inform the Building Designer of all information pertinent to the roof regarding its interaction with the supporting structure and adjacent elements of the building.

If no person is appointed specifically as the Roof Designer it falls upon the Building Designer to undertake the responsibilities of the Roof Designer.

3. Building Designer

On every project it is essential that one person assume overall responsibility as Building Designer.

The Building Designer may be the owner of the building, his appointed Architect, a Structural Engineer appointed by the owner or Architect, or the Contractor or Builder.

The Building Designer is responsible for providing the information listed in Section: 1.3 (and in section 11.1 of BS.5268-3) to the trussed rafter designer and for ensuring adequate provision is made for the stability of the individual trussed rafters.

The Building Designer is responsible for detailing all elements of bracing required in the roof, including that necessary to provide the lateral restraints to truss members required by the Trussed Rafter Designer.

The Building Designer is also responsible for detailing suitable fixings for both the trussed rafters and the wall plates to provide the restraint against uplift required by the Trussed Rafter Designer.

Exchange of Information

Please refer also to BS.5268-3 Section 11

Information to be provided to the Trussed Rafter Designer by the Building Designer

1. The position of roof hatches, chimneys, walkways and other openings.
2. The service use of the building in respect of any unusual environmental conditions and type of preservative treatment if required.
3. The spacing of the trussed rafter and any special timber sizes in particular if matching with an existing construction.
4. The site snow load or basic snow load and site altitude, or OS grid reference for the site.
5. The position, dimensions and shape of any adjacent structures higher than the new roof and closer than 1.5m.
6. Any special requirement for minimum member thickness (eg. For the purposes of fixing ceiling boards or sarking).
7. The height and location of the building with reference to any unusual wind conditions.
8. The profile of the trussed rafter (including any required camber).
9. The span of the trussed rafter (overall wall plates or overall length of ceiling tie or both as appropriate).
10. The pitch or pitches of the roof.
11. The method and position of all supports.
12. The type and weight of roof tiles or covering, including sarking, insulation and ceiling finishes.
13. The size and position of water tanks, or other equipment and plant to be supported by the trussed rafters.
14. The overhangs of the rafters at the eaves or apex if appropriate and details of any special eaves details.

Information to be provided by the Trussed Rafter Designer to the Building Designer

The Trussed Rafter Designer should provide the Building Designer with the following information, on suitably detailed drawings, to enable a check to be made that trussed rafters supplied are suitable for their intended use:-

1. The methods of support for tanks and other equipment, together with the capacity or magnitude of the additional load assumed.
2. The range of reactions to be accommodated at the support positions including those required to resist wind uplift forces.
3. The basis of the design.
4. Details of changes in spacing required to accommodate any opening eg. At a chimney.
5. Any special precautions for handling, storage and erection of the roof trusses, in addition to those covered by BS.5268-3.
6. Finished sizes, species, strength classes of members.
7. The type, sizes and positions of all jointing devices with tolerances or the number of effective teeth or nails (or plate areas) required in each member at each joint.
8. The position and size of all bearings.
9. Loadings and other conditions for which the trusses are designed.
10. The spacing of the trussed rafters.
11. The position, fixings and sizes of any lateral supports necessary to prevent buckling of compression members.

Limits of use for Trussed Rafters

Trussed rafters provide a flexible method of framing many required roof profiles. However, due to the commercial limits of available timber sections, transport limitations for length and height and

manufacturing limitations of the pressing machinery, the following section provides some ideas as to the types of truss available in the UK and Eire at present.

Physical Dimensions

Trussed rafters can be manufactured in spans up to approximately 20 metres and heights up to approximately 5 metres, although the more normal range is 15 metres span and 3.5 metres high.

Trusses outside the above ranges may be manufactured in two or more sections and site-assembled to the required profile (see section 3.4 on two-tier construction).

Timber Sections

Trussed rafters up to 11 metres in span will generally be fabricated from minimum 35 mm thick timbers. For trusses over 11 metres and up to 16 metres in span, thicker timber sections up to 47mm wide will

be used. Above 16 metres in span trusses will consist of multiple trussed rafters permanently fastened together by the manufacturer in the factory, or a greater width than 47mm may be used.

Profile

Within the above physical limits, many profiles of roof truss are possible, depending on the requirements of the roofscape. The creation of cantilevers over supports, the cutting back of a profile to form a recessed 'bobtail' area, the introduction of a pitched ceiling to form a 'scissor' truss, the creation of hip end and corner framing and many more common and not so common roof shapes are easily achieved by specification of trussed rafters.

It should also be remembered that, to avoid problems with both manufacturing and deflection of the roof structure, the trussed rafter profile should be of sufficient depth overall.

The recommended minimum depth for manufacturing purposes is approximately 600mm. The recommendation for structural depth is that the span of the trussed rafter divided by its overall depth should not be greater than 6.67. (This is known as the span to depth ratio).

Cantilevered hip ends and corners can create problems due to a pivoting effect if the cantilever distance is very large and will also require special propping arrangements to be made for loose timber hipboards and jack rafters.

Careful geometry checks should be made if a cantilevered area and an area with standard bearing abut each other to avoid any problems with roof alignment.

Basic Design Principles

A trussed rafter is an engineered framework consisting of structural members forming triangles. The framework derives its inherent strength from this triangulation.

The members around the perimeter of the trussed rafter are known as Chords (top and bottom, also called rafters and ceiling ties), and the internal

members providing the internal triangles are known as Webs (sometimes also called struts and ties).

A true trussed rafter is formed only when the webs form triangles between the top and bottom chords. Attic frames and Raised-Tie trusses (see section 1.7 and 3.13), do not provide this triangulation and are therefore technically not trussed rafters.

Principles of design

When loading is applied to a trussed rafter (from tiles, ceiling construction, snow etc), forces are generated in the members forming the truss.

The magnitude of the bending moment in a particular chord is largely due to the Panel Length (the distance between the joints at each end of the member, usually measured horizontally, also known as the Bay

Length). The general rule is, the longer the panel length the greater the bending moment and hence the larger the section of timber required to safely resist these forces.

Further, BS.5268-3 defines the maximum bay lengths permitted in Table 3 (page 5) a copy of which is given below:

Figure 1

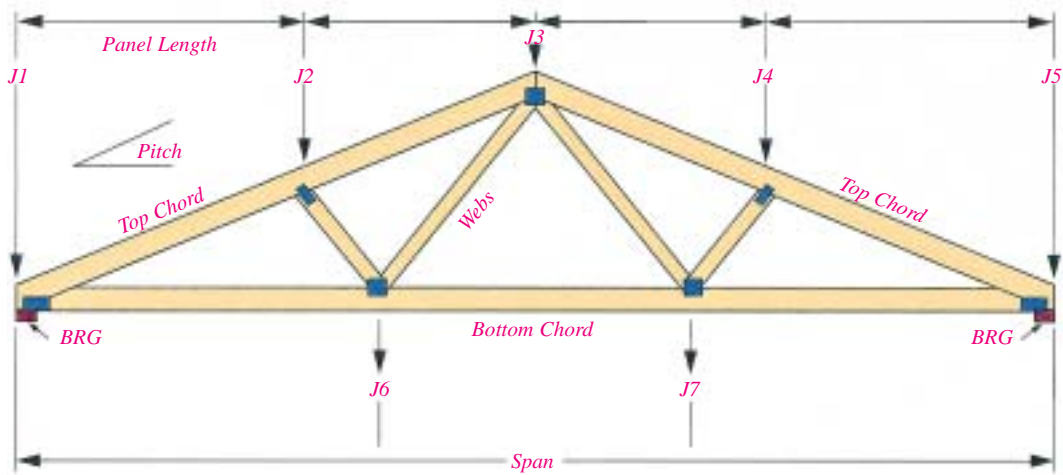

Table 3: Maximum Bay Lengths of Rafters and Ceiling Ties

Depth of member	Maximum length (measured on plan between node points)			
	35mm thick		47mm thick	
	Rafter	Ceiling Tie	Rafter	Ceiling Tie
Mm	m	m	m	m
72	1.9	2.5	3.3	3.3
97	2.3	3.0	3.6	4.3
120	2.6	3.4	3.9	5.0
145	2.8	3.7	4.1	5.3

These lengths are to ensure robustness of the truss during manufacture and handling. The choice of a different truss type with a smaller

panel length (and hence more webs) will usually yield a smaller section of timber required.

Basic Design Principles

Deflection

Another important criterion in the design of trussed rafters, which must be considered, is the amount of deflection, or movement of the truss when loading is applied to it.

BS.5268-3 section 6.5.7 defines the amount of

movement permitted under the differing load conditions (also see section 2.4).

Additionally, The Trussed Rafter Designer should be aware of the problems which may arise due to ***DIFFERENTIAL DEFLECTION.***

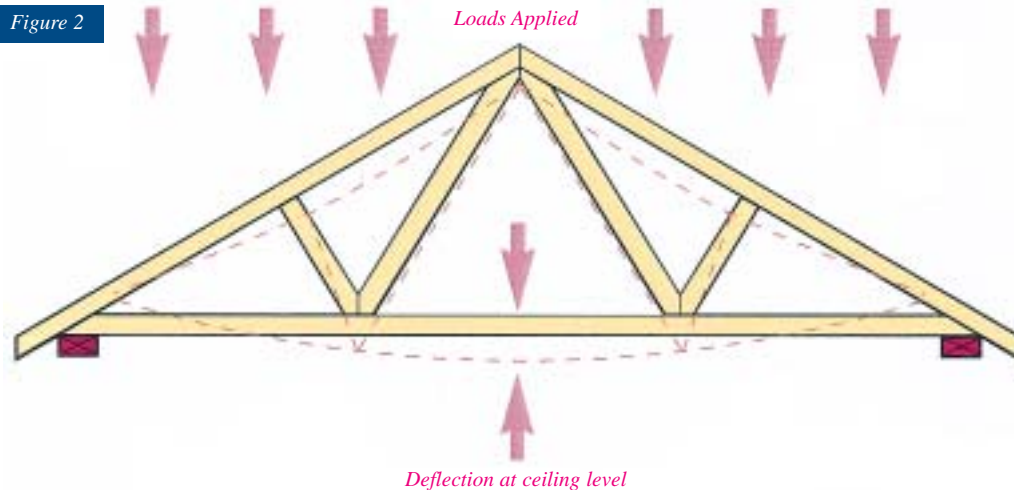

Differential deflection may occur between two adjacent trusses within a roof when either the support conditions or the loading conditions change. For example, in a hip end or corner condition (see sections 2.9 & 3.5), the heavily loaded girder truss may deflect more than the truss immediately behind it in the hip sequence. Or, where a bobtail, (stub) truss is used adjacent to a full span truss, the deflection of the standard truss may be substantially greater than that for the bobtail.

This problem of differential deflection between adjacent units is one of the most common causes of site problems and, once the roof is erected, one of the most difficult to rectify. The remedy is for the Designer to be full ware of the potential problem at the design stage.

In this situation, the Designer should ensure that the difference in anticipated deflection between the two trusses is kept within limits, to avoid problems in producing a smooth line for the ceiling construction underneath.

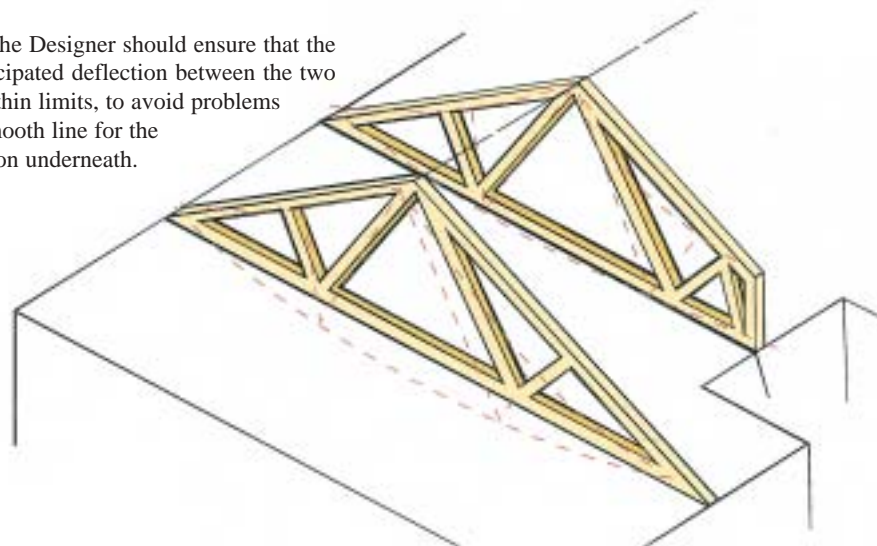

Guide to Setting Out & Dimensioning

As outlined in BS.5268-3, in order to ensure that trussed rafters are correctly designed and fabricated and that they are suitable for their intended purpose it is necessary for them to be accurately specified and for adequate information to be available when required.

At MiTek we have developed a number of standard trussed rafter configurations, as shown in figure 4, to which dimensions can be related, this simplifies the specification for design purposes.

Figure 4

Outside Shape	MiTek Shape Number	Truss Description	Outside Shape	MiTek Shape Number	Truss Description
<i>Triangulated Trusses</i>			<i>Triangulated Trusses</i>		
	00-02 (25-27)	Standard Truss or Duopitch (Asymmetric version also possible)		45	Sloping Flat with Apex/Double Bobtail
	05, 10	Single Cantilever Duopitch		40, 46 52, 58 87, *	Flat *Additional shapes with modified support positions are available
	11	Double Cantilever Duopitch		59, 63	Half Hip
	14-19	Bobtail Duopitch		64, 68	Hip
	14-19	Bobtail Duopitch with Nib	<i>Non-Triangulated Trusses</i>		
	20-21	Monopitch		Various	Attic Truss
	20-21	Monopitch with Nib		Various	Attic Truss (Centre Support)
	35	Scissors		Various	Extended Rafter (Raised tie) Truss

Key

- O Overhang
- SOP Span over setting out points
- SW Span over wallplates
- SC Span over ceiling tie
- C Cantilever
- N Nib
- RW Room width
- RH Room height
- SL Slope length

N.B. Not all of the MiTek Range Of Trusses Are Indicated above

Guide to Setting Out & Dimensioning

Setting out and Eaves details

Although often employed as the principle truss type in association with appropriate architectural features of a building, the bobtail is most often needed to accommodate re-entrant areas in perimeter walls as shown in figure 5. The horizontal 'A' dimension indicated in figure 6 therefore, is conveniently used to specify the shape for duo-pitch trusses, while double bobtails and bobtailed mono-pitched trusses which more often are principle trusses are more conveniently specified by a vertical 'A' dimension.

Figure 7a shows typical end details when the outer leaf is of masonry, arrangement (b) is best confined to timber frame construction as separate columns of masonry between trusses could be rather unstable. If the end verticals are to be tile clad one of the

arrangements figure 7c or d is suitable. In (c) a specially wide timber is used as the end vertical of the truss so that the tile battens clear the outer leaf of the wall; the inside of the end vertical must not be located to the right of the centre-line of the wall plate. In some cases the arrangement is impractical owing to the large width required for the end vertical. In many cases the diagonal in the cantilevered part (figure d) can be omitted if there is little load from the cladding.

A special bobtail can be designed to suit practically any requirement.

Bobtailed trusses must never be formed through do-it-yourself site modifications of standard truss types with which they align.

Figure 5

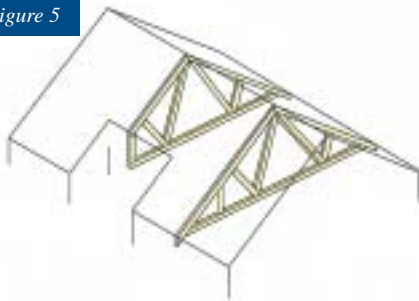

Figure 6

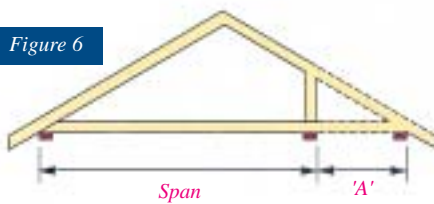

Figure 6a

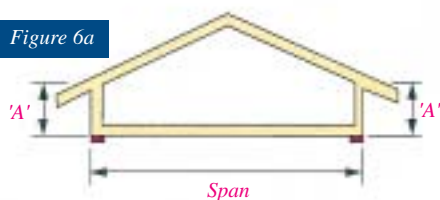

Figure 6b

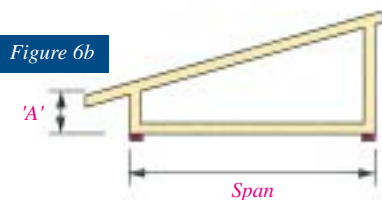
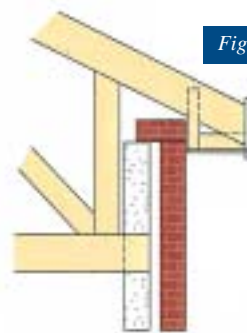

Figure 7a



Masonry inner leaf with timber nib

Figure 7b



Timber frame

Figure 7c

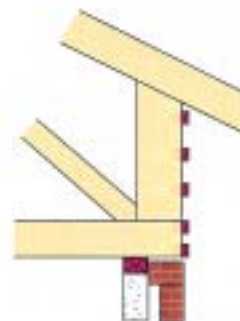

Tile clad end vertical

Figure d

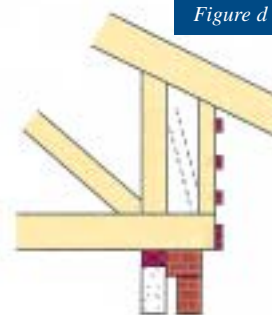

Tile clad end vertical

Guide to Setting Out & Dimensioning

Support details - Cantilevers

The reaction from the bearing is the greatest load (although upwards) to which a truss is subjected and in order to control excessive bending in the supported chord it is important, except in the smallest trusses, to locate a joint at each bearing. The normal eaves joint illustrated in figure 8a accomplishes this if the "Shift" dimension is less than 50mm, or one-third of the scarf length, whichever is the greater.

If the Shift is greater than the allowed a stress check is required on the short cantilever.

Unfortunately there is usually insufficient space for an additional web so should the check fail, as it often does, it is necessary to increase the size of the bottom chord or alternatively incorporate a relief rafter, (as

shown in figure 10b) or a heel wedge. Both of these options can add to the final cost of the truss and therefore it is best to avoid cantilevers in this range.

If the "Shift" is greater than two scarf lengths, then a standard cantilever truss as show in figure 10a is employed. The chord sizes are usually no greater than the corresponding non-cantilevered standard truss and the cost is little more. Many variations are possible by adjusting the position of a joint of a non-cantilevered standard truss type so that it is over a bearing. Finally, if required, a non-standard cantilever truss of almost any triangulated configuration can be designed and fabricated. Note that a brace may sometimes be required on the bottom chord which is untypically in compression.

Figure 8a Standard truss

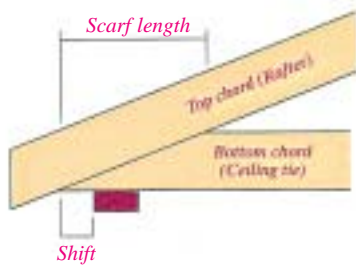

Shift = max x 50mm or 1/3 scarf length whichever is the greatest

Figure 8b Check bottom chord

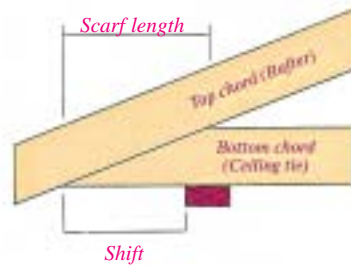

Standard cantilever

Figure 10a

Bottom chord may need brace

Figure 10

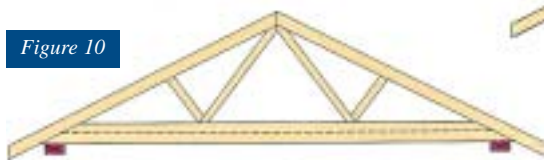

Increase bottom chord

Figure 10b

Incorporate relief rafter or slider

Figure 9

Alternative configurations

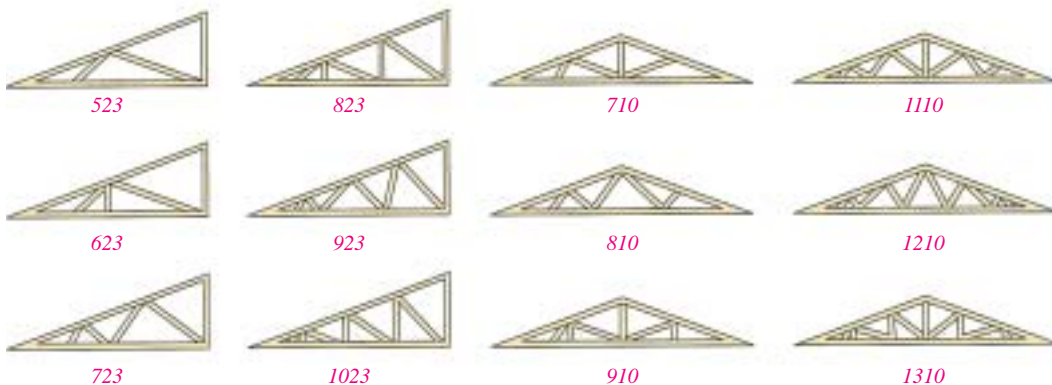

Practical Roof Solutions

Hipped Ends

The good performance of MiTek designed hipped ends does not depend on tension in battens, a massive wallplate and horizontal thrust on walls. Indeed, with suitable bracing, walls are provided with the stability called for by the Building Regulations. The most simple and lowest cost form of MiTek hipped end, (shown in figure 11a) consists of a multi-ply girder of standard trusses securely fixed together and supporting loose rafters and ceiling joists. Such constructions are limited to spans generally not exceeding 5m. Sizes of rafters and ties can be found in approved document 'A' of the Building Regulations. Hip boards should be supported off the girder by means of a ledger and the ceiling joists by means of proprietary joist hangers.

The 'step-down' system incorporates flat-top hip trusses of progressively diminished height from the ridge to the girder. The number of step-down trusses is determined by the necessity of maintaining reasonable sizes for the loose ceiling joists and hip board on the hipped corner infill areas, as shown in figure 11b. For these reasons the span of the mono-pitch trusses is not usually greater than 3m in the case of regular hips (where the end pitch is the same as the pitched of the main roof).

Noggings have to be fitted between the flat chords of the step-down hip trusses to support the tiling battens. The web configurations of the various truss types shown (including the mono-pitch) are typical but will be chosen to provide the best structural solutions.

This step-down hip system is no longer very popular as it requires many different truss profiles to be made.

The 'flying rafter' hip system shown in figure 11c has the manufacturing advantage of there being only one basic hip truss profile. All of the hip trusses, including those forming the girder are similar, and the mono-pitch trusses supported off the girder usually have the same profile as the sloped part of the hip trusses which speeds up fabrication.

The rafters of the mono-pitched trusses are site cut to sit against the upper hip board and the off-cuts are nailed in position to the rafters of the hip trusses. The flat parts of the top chords of the hip trusses and girder are well braced together to prevent instability.

While the hipped corner infill is shown as prefabricated rafter-joist components (open jacks), it is usually cheaper to site fabricate in these areas. The lower hip board is typically notched and supported off a 50 x 50mm post nailed to the girder truss. The upper hip board can be supported off ledgers and in some cases is propped off the hip trusses underneath.

The system offers the advantage of continuous rafters and consequently easily constructed smooth roof slopes. On long spans it may be necessary to use a second hip girder between the apex and monos.

Figure 11a



Figure 11c

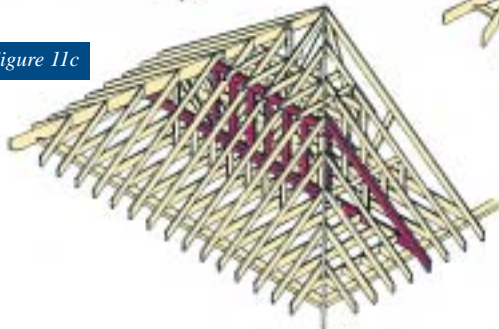
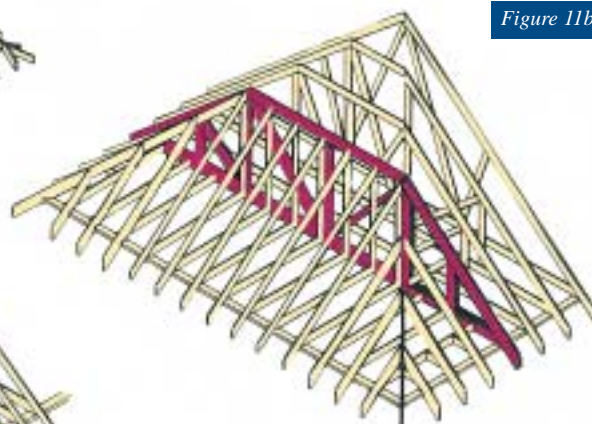

Figure 11b



Rafter noggings not shown for clarity

Practical Roof Solutions

T Intersection & Valley Infill

The 'T' is probably the most common kind of roof intersection (as demonstrated in figure 12). The roof truss arrangement at this feature includes a specially designed girder truss (shown in figure 13), usually consisting of two to four individual trusses connected together with nails or bolts, which support the incoming trusses. Support of the incoming trusses is off the bottom chord of the girder through girder truss shoes.

The design of the valley frame infill continues the rafter profiles of the opposing roof slopes to form an intersection, and transfers the tile loading uniformly to the top chords of the underlying trusses.

Typical girder truss

Figure 13

Howe

Double Howe



Figure 12

Diminishing valley frames to be nailed direct onto the main trussed rafters

Standard truss to main roof

Layboards (if required) are to comply with the manufacturers details

Standard trusses on return roof

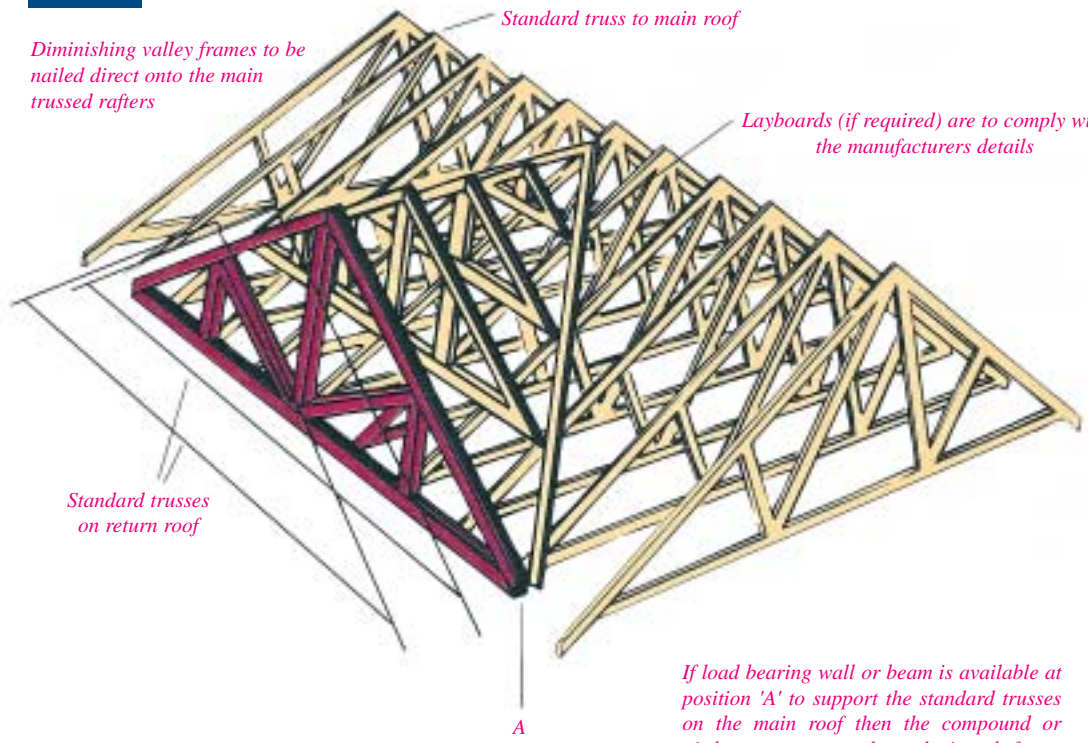

If load bearing wall or beam is available at position 'A' to support the standard trusses on the main roof then the compound or girder trusses can be substituted for a standard truss on the return roof

Practical Roof Solutions

Corners

There are two basic methods of forming a corner:

1. Hipped Corner

A hipped corner is formed by the perpendicular intersection of two roofs which may or may not be of the same span.

The principle for the hipped corner construction is the same as for full hips except that the truss profiles are generally sloped on one side only. The support

across the junction is again provided by either a girder truss or a wall/beam. When a girder truss is specified provision has to be made for a special hanger to carry the girder truss supporting the hipped end. Mono valley frames are required to complete the framing of the corner.

Figure 14a

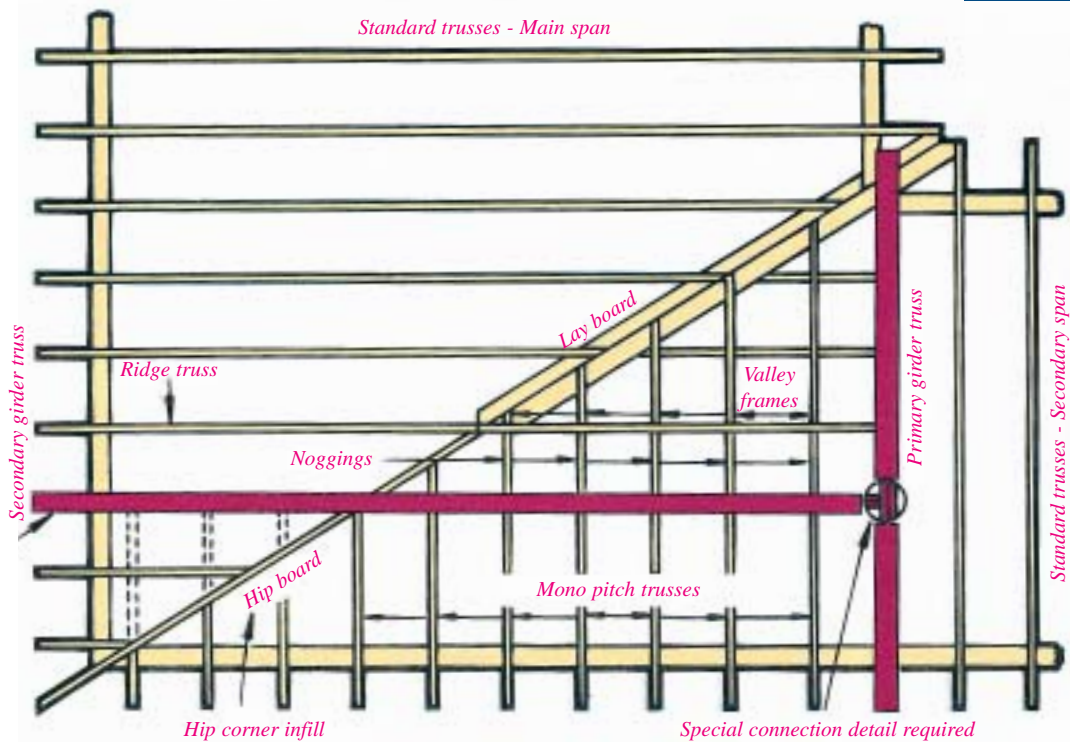

2. Skew Corners or Dog-Legs

A skew corner is formed by the intersection of two roofs at an angle greater than 90 degrees. The corner is generally framed by positioning a girder truss at the extremity of the two straights with an additional girder positioned across the corner as in figure 14b.

The girder units will typically support loose infill on

purlins and binders to maintain the roof plane. The feasibility of framing in this manner is dependant solely upon the span of the longest purlin.

It is not recommended to incorporate hipped ends and tee intersections into skew corners unless a feasibility study has been undertaken before planning has become too far advanced.

Figure 14b

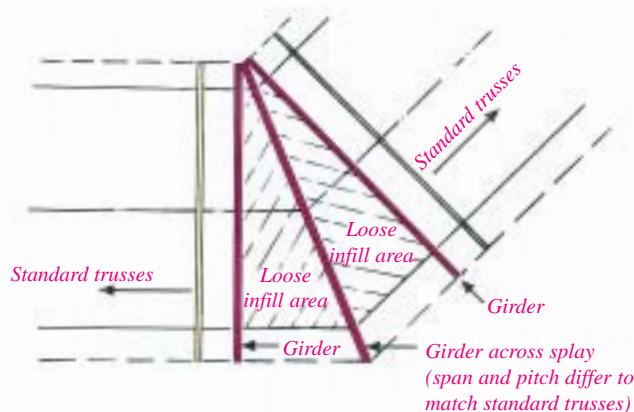

Practical Roof Solutions

Extended Rafters and Extended Joists

Extended rafters and extended joists, as shown in figure 15 require special consideration because the trusses are not fully triangulated to the bearings. As a result of the lack of triangulation, the extended member is subject to exceptionally large bending moments. In the example shown in figure 16 the rafter, or the top chord, is subject to a bending moment no less than ten times that which occurs in a conventionally supported truss.

Standard trusses can be adapted and strengthened to withstand the large bending moments and shear force occurring in the extended member at the rafter-tie junction. This may be accomplished by fixing a strengthening piece to each side of the extended member, using bolts or a special nailing arrangement. Another way to strengthen the

extended rafter is by using a factory fitted stack chord as shown on the right-hand side of figure 16.

Large rafter extensions will produce outward thrust and movement at the bearings. This is often a critical factor in design and is rigorously controlled by BS.5268-3.

Figure 15

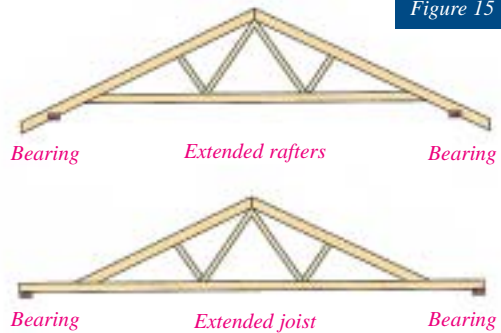
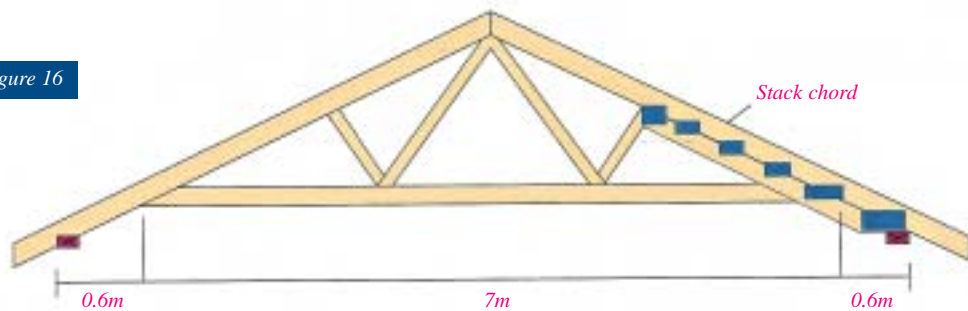

Figure 16



Hatch and Chimney Opening

Where possible, hatches and chimneys should be accommodated in the standard spacing between trusses. Each member and joint in a truss performs an important role essential to the effective functioning of all other parts and the component as a whole. Trusses must never be cut and trimmed except according to details supplied by the truss designer. The full detailing of the construction of these features is given in section 3.3.

Figure 16a

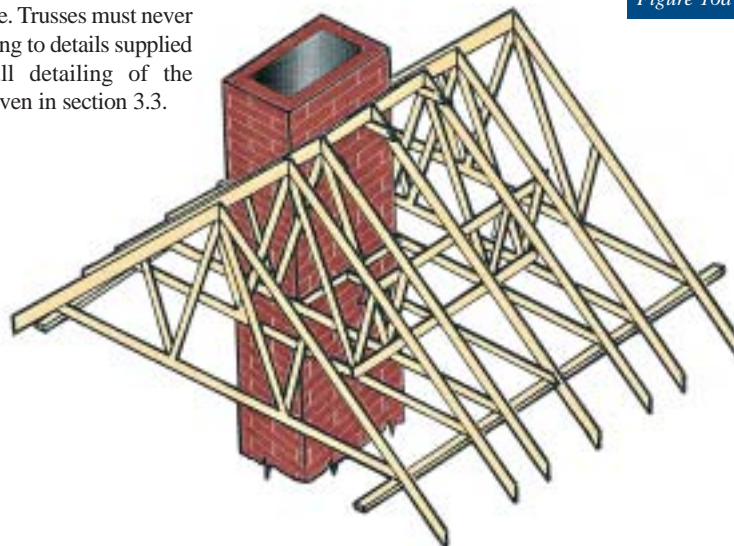

Practical Roof Solutions

Room-in-the-Roof: Attic Frames

The special advantage of attic frames is that they enable the upper floor of a building to be totally contained within the roof, increasing the habitable area by 40-50% at little extra cost. The bottom chords become the floor joist of the room, their size having been calculated to cater for increased loads.

Attic Frames can be designed to allow 'clear span' supported at eaves only, (as shown in figure 17a), however for longer spans it may be necessary to incorporate an intermediate support (shown in figure 17b). This will allow either larger internal room dimensions or reduce the timber sections required. Since attic frames are non-triangulated, the timber content will be considerably greater than that required for a comparable trussed rafter.

Where a more complex attic roof layout is being planned, for example where hipped ends, corners or intersections may occur, it is recommended that a truss designer is contacted to prepare a feasibility study at an early stage of the project.

Dormer Window and Stairwell Locations

The same principles that apply to ordinary roof trusses also apply to attic frames. If a truss is severed or weakened at any point the structural integrity of the whole truss is effected. Therefore, if an opening is planned, the roof must be strengthened by additional frames at smaller than standard spacings or girders at each side of the opening. Guidelines to these details are given in section 3.3.

Having acknowledged these principles, there is relative freedom in the methods of framing out the actual openings, however there are sensible economic factors to be considered. Obviously it is of most advantage to locate window openings on different sides of the ridge and directly opposite each other in order that they will lie between the same two trimming trusses. If not, the extent of additional loose infill timber may completely negate the advantages of using prefabricated attic frames. Where possible stairwells should be located parallel to the trusses otherwise, once again, the increase in site infill timber may nullify the benefits of using attic frames.

The following diagram (figure 18) demonstrates the most economic method of incorporating openings to the roof space, whilst figure 19 requires increased loose infill timbers and site work if practical recommendations are not followed.

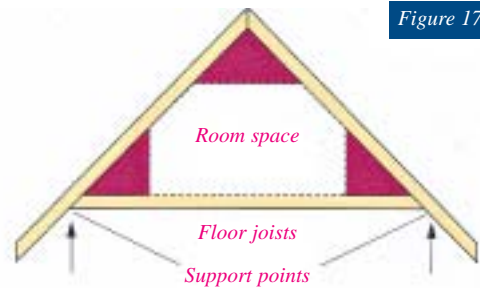

Figure 17a

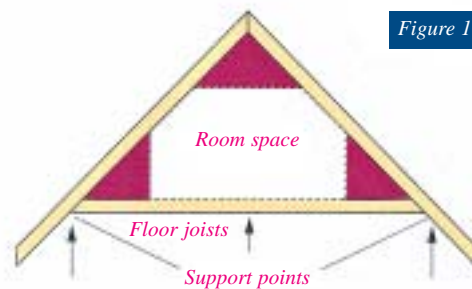

Figure 17b

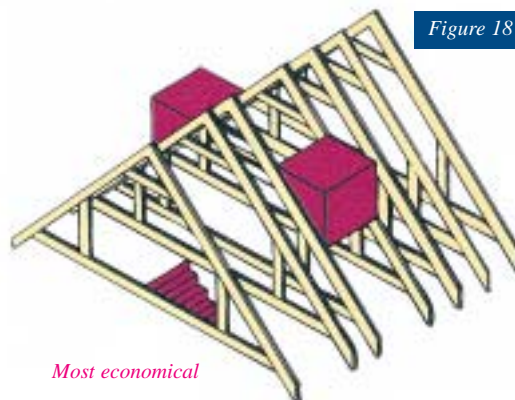

Figure 18

Most economical

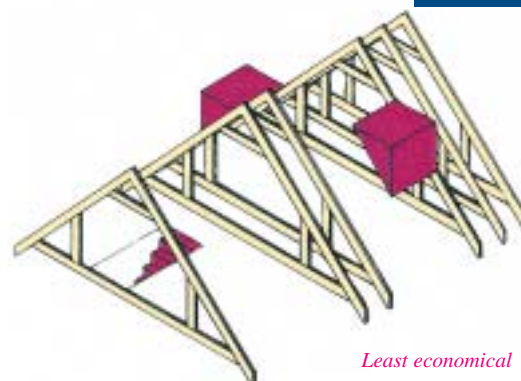

Figure 19

Least economical

Glossary of Terms used in Trussed Rafter Construction

Apex/Peak

The uppermost point of a truss.

Attic Truss/room-in-the-Roof

A truss which forms the top storey of a dwelling but allows the area to be habitable by leaving it free of internal WEB members. This will be compensated by larger timber sizes elsewhere.

Bargeboard

Board fitted to conceal roof timbers at a GABLE END.

Battens

Small timber members spanning over trusses to support tiles, slates etc.

Bearer

A member designed to distribute loads over a number of trusses.

Binder

A longitudinal member nailed to trusses to restrain and maintain correct spacing.

Birdsmouth

A notch in the underside of a RAFTER to allow a horizontal seating at the point of support (usually used with RAISED TIE TRUSSES).

Blocking

Short timbers fixed between chords to laterally restrain them. They should be at least 70% of the depth of the chords.

Bobtail

A truss type formed by truncating a normal triangular truss.

Bottom Chord

See CEILING TIE.

Bracing

This can be Temporary, Stability or Wind Bracing which are described under these headings.

Building Designer

The person responsible for the structural stability and integrity of the building as a whole.

Camber

An upward vertical displacement built into a truss in order to compensate for deflection which might be caused by the loadings.

Cantilever

The part of a structural member of a TRUSS which extends beyond its bearing.

Ceiling Tie

The lowest member of a truss, usually horizontal which carries the ceiling construction, storage loads and water tank.

Chevron Bracing

Diagonal web bracing nailed to the truss in the plane of the specified webs to add stability.

Connector Plate/fastener

See NAILPLATE.

Cripple Rafter

See JACK RAFTER.

Dead Load

The load produced by the fabric of the building, always long term (see DESIGN LOADS).

Deflection

The deformation caused by the loads.

Design Loads

The loads for which the unit is designed. These consider the duration of the loads long term, medium term, short term and very short term.

Duo/dual Pitch Truss

A truss with two rafters meeting at the APEX but not necessarily having the same PITCH on both sides.

Dwangs

See NOGGINGS.

Eaves

The line between the rafter and support wall.

Eaves Joint

The part of the truss where the rafter and the ceiling tie intersect. This is usually where the truss is supported.

Extended Rafter

See RAISED TIE TRUSS

Fascia

Horizontal board fitted around the perimeter of the building to the edge of the truss overhangs.

Fastener

See NAILPLATE.

Fink Truss

The most common type of truss used for dwellings. It is duo-pitch, the rafter having the same pitch. The webs form a letter W.

Firring Piece

A tapered timber member used to give a fall to flat roof areas.

French Heel

An EAVES joint where the rafter sits on the ceiling tie.

Gable End

The end wall which is parallel to the trusses and which extends upwards vertically to the rafters.

Glossary of Terms used in Trussed Rafter Construction

Hip End

An alternative to a GABLE END where the end wall finishes at the same height as the adjacent walls. The roof inclines from the end wall, usually (but not always) at the same PITCH as the main trusses.

Hip Set

The trusses, girders and loose timbers required to form a hip end.

Horn/nib

An extension of the ceiling tie of a truss (usually monos or bobtailed trusses) which is built into masonry as a bearing.

Imposed Load

The load produced by occupancy and use including storage, inhabitants, moveable partitions and snow but not wind. Can be long, medium or short term.

Internal Member

See Webs.

Intersection

The area where roofs meet.

Jack Rafter

An infill rafter completing the roof surface in areas such as corners of HIP ENDS or around chimneys.

Live Load

Term sometimes used for IMPOSED LOADS.

Longitudinal Bracing

Component of STABILITY BRACING.

Loose Timber

Timbers not part of a truss but added to form the roof in areas where trusses cannot be used.

Mono-Pitch Truss

A truss in the form of a right-angled triangle with a single rafter.

Nailplate

Metal PLATE having integral teeth punched from the plate material. It is used for joining timber in one plane with no overlap. It will have an accreditation certificate and will be manufactured, usually, from galvanised steel. It is also available in stainless steel.

Nib

See HORN

Node

Point on a truss where the members intersect.

Noggings

Timber pieces fitted at right angles between the trussed rafters to form fixing points.

Overhang

The extension of a rafter or ceiling tie of a truss beyond its support or bearing.

Part Profile

See BOBTAIL.

Peak

See APEX.

Permissible Stresses

Design stresses for grades of timber published in BS5268: Part2:

Pitch

The angle of the chords to the horizontal, measured in degrees.

Plate

See NAILPLATE.

Purlins

Timber members spanning over trusses to support cladding or between trusses to support loose timbers.

Quarter Point

The point on a rafter where the web intersects in a FINK TRUSS.

Queen

Internal member (WEB) which connects the APEX to a third point on a FINK TRUSS.

Rafter

The uppermost member of a truss which normally carries the roof covering.

Rafter Diagonal Bracing

Component of STABILITY BRACING.

Raised Tie Truss

A truss which is supported at a point on the rafter which is beyond the point where the rafter meets the ceiling tie.

Reducing Trusses

See VALLEY FRAMES.

Remedial Detail

A modification produced by the TRUSSED RAFTER DESIGNER to overcome a problem with the truss after its manufacture.

Return Span

The span of a truss being supported by a girder.

Ridge

The line formed by the truss apexes.

Ridgeboard

Timber running along a ridge and sandwiched between loose rafters.

Roof Designer

The person responsible for the roof structure as a whole and who takes into account its stability and capability of transmitting wind forces on the roof to suitable load-bearing walls.

Glossary of Terms used in Trussed Rafter Construction

Room-in-the-Roof

See attic truss.

Scab

Additional timber fitted to the sides of a truss to effect a local reinforcement, particularly in raised tie trusses.

Setting Our Point

The point on a truss where the undersides of the rafter and ceiling tie meet.

Skew Nailing

A method of fixing trusses to the wallplate by driving nails at an angle through the truss into the wallplate which is generally not recommended. (See Truss Clip).

Soffit

Board fixed underneath eaves overhang along the length of the building to conceal timbers.

Span

Span over wallplates is the distance between the outside edges of the two supporting wallplates. This is usually the overall length of the ceiling tie.

Spandrel Panel

A timber frame, triangular panel forming the gable wall above the ceiling line.

Splice

A joint between two members in line using a nailplate or glued finger joint.

Spreader Beam

See bearer.

Strap

Metal component designed to fix trusses and wallplates to walls.

Strut

Internal compression member connecting the third point and the quarter point on a Fink truss.

Stub End

See bobtail.

Temporary Bracing

An arrangement of diagonal loose timbers installed for safety during erection. Often incorporated with permanent stability and wind bracing structures.

Third Point

Point on the ceiling tie where the internal webs meet in a fink truss.

Timber Stress Grading

The classification of timber into different structural qualities based on strength (see BS4978: 1996).

Top Chord

See rafter.

TRADA Quality Assurance Scheme

Quality control method in truss manufacture administered by the BM TRADA Certification.

Trimmer

A piece of timber used to frame around openings.

Truss/Trussed Rafter

A lightweight framework, generally but not always triangulated, placed at intervals of 600mm to support the roof. It is typically made from timber members of the same thickness, fastened together in one plane using nailplates or plywood gussets.

Trussed Rafter Designer

The person responsible for the design of the trussed rafter as a component and for specifying the points where bracing is required.

Truss Clip

A metal component designed to provide a safe structural connection of trusses to wallplates. Also to resist wind uplift and to prevent the damage caused by skew nailing.

Truss Shoe

A metal component designed to provide a structural connection and support for a truss to a girder or beam.

Uniformly Distributed Load

A load that is uniformly spread over the full length of the member.

Valley Board

A member raking from incoming ridge to corner in a valley construction.

Valley Frames/Set

Infill frames used to continue the roofline when roofs intersect.

Verge

The line where the trussed rafters meet the gable wall.

Wallplate

A timber member laid along the length of the load bearing walls to provide a level bearing and fixing for the trusses.

Webs

Timber members that connect the rafters and the ceiling tie together forming triangular patterns which transmit the forces between them.

Wind Bracing

An arrangement of additional timbers or other structural elements in the roof space, specially designed to transmit wind forces to suitable load-bearing walls.

Technical Information

Codes and Standards

Design Compliance

Design loadings accord with the following:-

The Building Regulations England and Wales,

The Building Regulations Scotland,

Irish Standard 193: Timber trussed rafters,

BS 6399: Part 1: Code of practice for dead and imposed loads,

BS 6399: Part 3: & amendments: Code of practice for imposed roof loads,

BS 6399: Part 2: Code of practice for wind loads.

Timber designs accord with the following:-

BS5268:-2: Structural use of timber, code of practice for permissible stress design, materials and workmanship.

BS 5268-3: Code of practice for trussed rafter roofs.

Connector plate design accord with the following:-

British Board of Agreement Certificate No: 90/2386,

WIMLAS Certificate 038/96 - MiTek M20 punched metal plate timber fasteners.

Timber

The timber used in the manufacture of trussed rafters in the UK and Eire is strength graded softwood.

The common sources of supply for the timber are Scandinavia, Baltic States, Canada and the USA. The last two countries provide only a minor proportion of the timber used in trussed rafters.

Timber is classified by either strength grade or strength class and this classification defines the working stresses which may be used to design with the particular timber involved.

Grading may be either manual, by trained graders, or mechanical, by use of a strength grading machine.

Machine strength graded timbers form the majority of timbers used in trussed rafters.

As each particular length of timber is classified, a grading mark or stamp is applied to show its classification.

When the timber is re-cut for use in trusses, the

Trussed Rafter Fabricator will mark the finished truss with the grades or strength classes of timber used, often by means of a label attached near the apex of the truss or by means of a stamp on the timber near the apex.

Maximum timber lengths of up to 6 metres are used, although lengths of 4.8 metres are commercially more common. This means that splice joints are frequently required in truss chord members, to achieve long spans. Please refer to section 2.4 concerning timber splicing.

The Designer will use the strength grade or strength class values when designing the members forming the truss. (See section 2.4, Design Method).

British Standard BS4978: - Specification for visual strength grading of softwood. BSEN 1313 - 1: Permitted deviations and preferred sizes of softwood sawn timber, together with BS 5268 - 3: Code of Practice for trussed Rafter Roofs govern the grading, sizing and use of the softwoods used in Trussed Rafter construction



Connector Plates

MiTek connector plates are manufactured from structural grade galvanised mild steel.

Many common types of nailplate are currently used in the UK and Eire: The 1.0mm M20, the 1.2mm B90, the 2.0mm M200 and several special plates including field splice plates.

For full details of the use of each type of nailplate, please refer to Agreement Board Certificate 90/2386, and Wimlas Certificate 038/96.

The difference in the formation of the nails (teeth) produced by the stamping-out process for each type of plate, together with the difference in steel

thickness and width used, produces a varying set of design parameters for each type of plate. Further, a large range of available sizes for each type of plate provides the designer with a very flexible system for the design of each particular joint.

To cater for the aggressive roof environments found in industrial or agricultural buildings, or for decorative purposes in exposed trussed situations, a reduced range of sizes with the M20 nail configuration is available in 20 gauge Stainless steel. Please note, however, that these are likely to add considerably to the cost of the finished roof trusses.

Figure 20

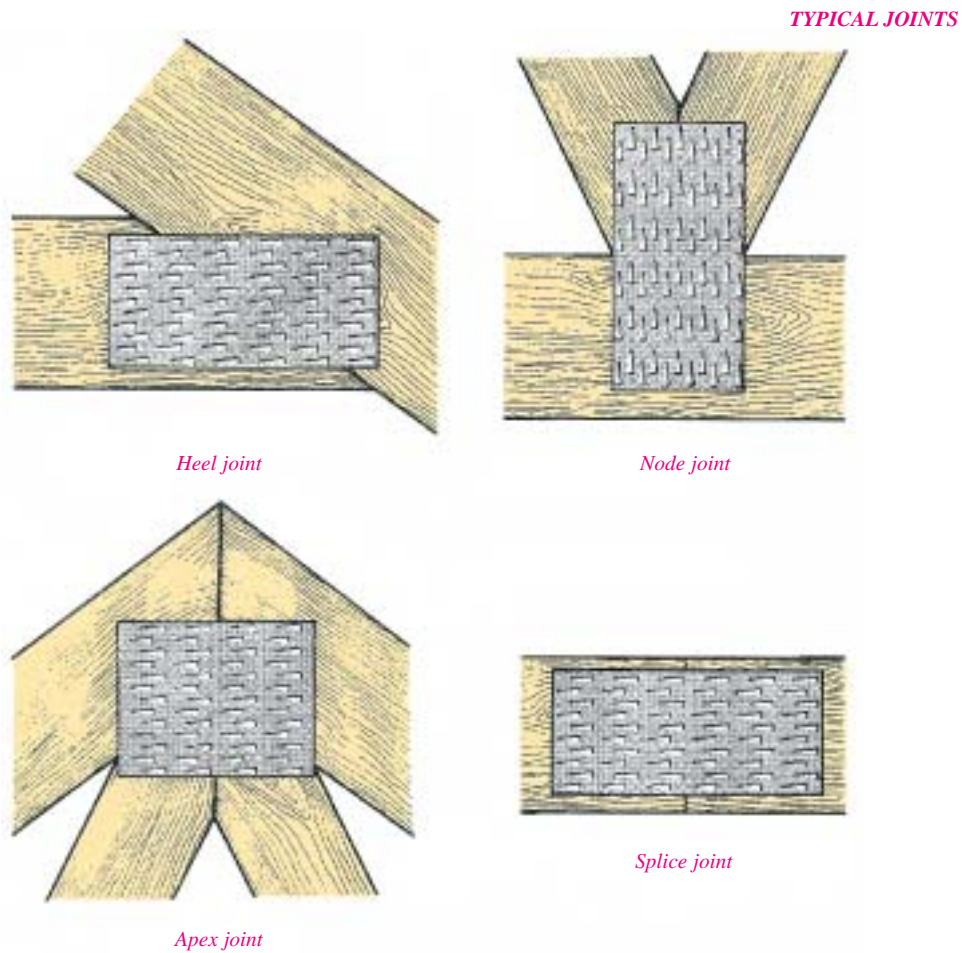

Design Method

A trussed rafter is an engineered framework consisting of structural members forming triangles. The framework derives its inherent strength from this triangulation.

The members around the perimeter of the trussed rafter are known as chords (top and bottom, also called rafters and ceiling ties), and the internal members providing the internal triangles are known as webs (sometimes also called struts and ties).

A true trussed rafter is formed only when the webs form triangles between the top and bottom chords. Attic frames and Raised-Tie trusses (see section 1.7 and 3.16) do not provide this triangulation and are therefore technically not trussed rafters.

When designing non-standard trussed rafters, it is beneficial to ensure the full triangulation as above, please refer to MiTek's System Design Office if in doubt.

Principles of Design

When loading is applied to a trussed rafter (from tiles, ceiling construction snow etc), two main kinds of force are generated in the members:

1. Bending Moment
2. Axial Force

Bending moment causes neighbouring sections of timber to tend to rotate relative to each other (see figure 21a).

Axial force may be either tensile, i.e. pulling adjoining sections of timber away from each other, or compressive, i.e. crushing adjoining sections of timber into each other (see figure 21b and 21c).

A compressive force may cause the member to buckle (bending sideways out of the plane of the trussed rafter) and this may need to be counteracted by bracing (see sections 2.5 and 3.7) or by increasing the section of timber required for the affected member.

Within a trussed rafter, members will be subject to either axial force alone or a combination of axial force and bending moment. The design of a trussed rafter must allow for these effects, together with the differing forces produced by different types of load (see section 2.7 on Loading and Load cases.)

Figure 21a

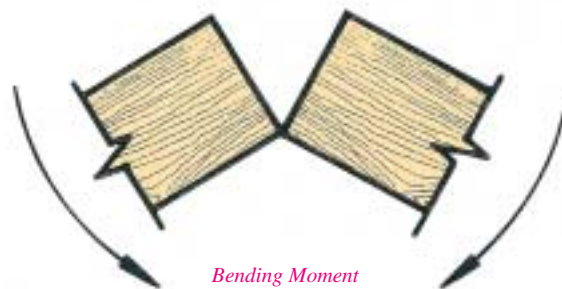

Figure 21b

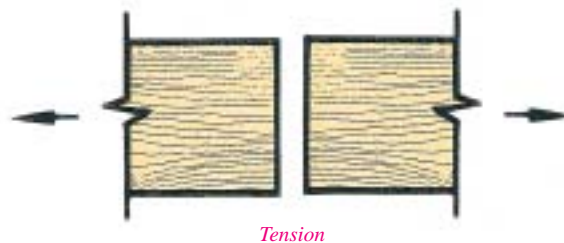
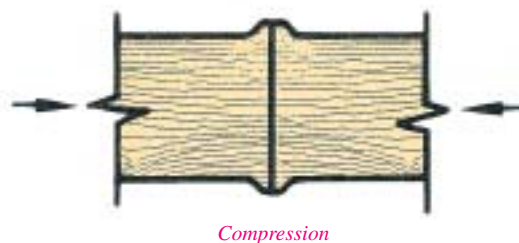

Figure 21c



Design Method

Bending Moments

Bending moments are generally induced in the Chord members due to the loadings (tiles, ceiling, snow etc) placed directly onto them. It is unusual for Web members to be subject to bending moments.

The magnitude of the bending moment in a particular chord is largely due to the Panel Length (the distance between the joints at each end of the member, usually measured horizontally, also known as the Bay

Length). The general rule is, the longer panel length the greater the bending moment and hence the larger the section of timber required to safely resist the bending moment.

Further, BS. 5268-3 defines the maximum bay lengths permitted in Table 3, a copy of which is given below:

BS 5268 Table 3: Maximum Bay Lengths of Rafters and Ceiling Ties

Depth of member	Maximum length (measure on plan between node points)			
	35mm thick		47mm thick	
	Rafter	Ceiling Tie	Rafter	Ceiling Tie
Mm	m	m	m	m
72	1.9	2.5	3.3	3.3
97	2.3	3.0	3.6	4.3
120	2.6	3.4	3.9	5.0
145	2.8	3.7	4.1	5.3

The choice of a different truss type, with a smaller panel length (and hence more webs), will usually yield a smaller section of timber required.

The method of calculation relating to bending moment is as follows:

The applied bending stress (calculated from the bending moment divided by the section modulus of the timber being considered) is compared with the permitted bending stress for the particular timber

grade or strength class.

The resulting ratio:

$$\frac{\text{Actual bending stress}}{\text{Permitted bending stress}} < 1$$

This ensures that the actual bending stress in the timber cannot exceed the permitted stress, causing the timber to fail.

Axial Force

Axial forces within the trussed rafter are calculated by analysing the whole frame. The greater the number of panels (webs) the greater the axial forces can be. Also, the lower the pitch of the top chord the greater can be the axial force.

As mentioned previously, axial force can be either tensile or compressive and, if compressive, can lead to problems with out-of-plane buckling.

In a similar way to bending moment, the actual axial stress in the timber (calculated from the axial force divided by the area of the timber section), is compared with the permitted axial stress of the timber grade or strength class being used.

This ensures that the timber never exceeds its permitted axial stress limit.

Generally, web members will be subjected only to axial force, whereas chord members will be subject to a combination of bending and axial stresses.

For chord members therefore, the calculation becomes:

$$\frac{\text{Actual bending stress}}{\text{Permitted bending stress}} + \frac{\text{Actual axial stress}}{\text{Permitted axial stress}} < 1$$

To ensure that the timber section is within its defined limits for both bending and axial stress.

This ratio is known as the combined stress index (CSI) or stress summation.

$$\frac{\text{Actual axial stress}}{\text{Permitted axial stress}} < 1$$

Design Method

Deflection

Another important criterion in the design of trussed rafters, which must be considered, is the amount of deflection, or movement of the truss when loading is applied to it. (See figure 22).

BS.5268-3 section 6.5.7 clearly defines how to calculate deflection and the permissible limits on rafters, ceiling ties and on overhangs and cantilevers.

Figure 22

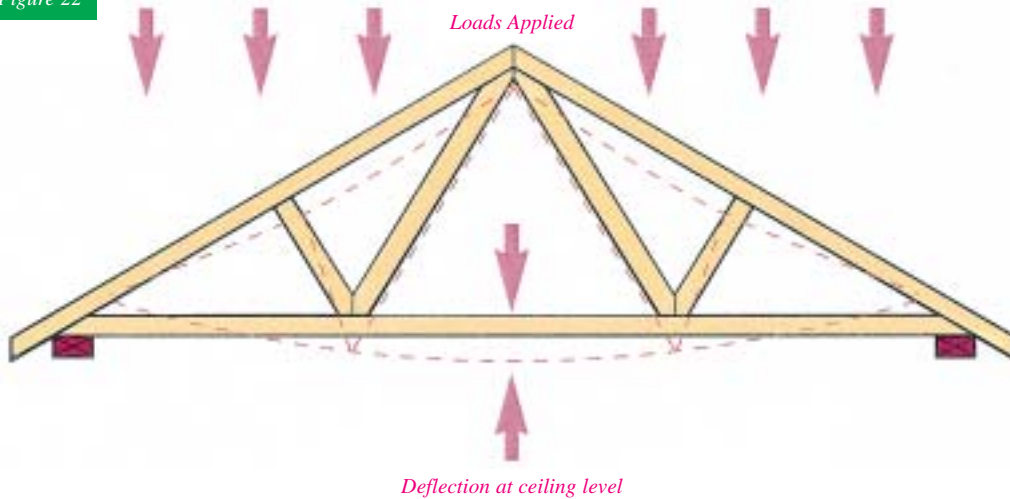

This therefore defines the amount of movement under the differing load conditions permitted.

In this situation, the Designer should ensure that the difference in anticipated deflection between the two trusses is kept within limits, to avoid problems in producing a smooth line for the ceiling constructions underneath.

Additionally, the Trussed Rafter Designer should be aware of the problems which may arise due to **DIFFERENTIAL DEFLECTION**.

This problem of differential deflection between adjacent units is one of the most common causes of site problems and, once the roof is erected, one of the most difficult to rectify. The remedy is for the Designer to be fully aware of the potential problem **at the design stage**.

Differential deflection may occur between two adjacent trusses within a roof when either the support conditions or the loading conditions change. For example, in a hip end or corner condition (see sections 2.8 and 3.5) the heavily loaded girder truss may show more anticipated deflection than the truss immediately behind it in the hip sequence. Or, where a bobtail (stub) truss is used adjacent to a full span truss, the deflection of the standard truss may be anticipated to be greater than that shown for the bobtail.

Figure 23

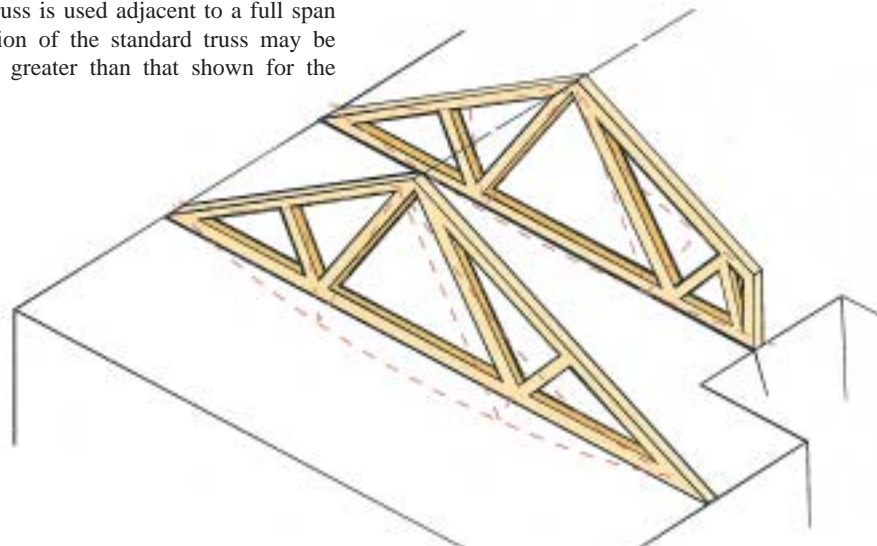

Design Method

The design of joints using Mitek nailplate connectors is governed by the British Board of Agreement Certificate 90/2386 and WIMLAS Certificate 038/96.

Within the approval certificates the conditions of use, assessment of fitness for purpose, sizes of available nailplates, methods of joint assembly, relevant loadings etc are specified. It is not intended in this document to reproduce in part or in whole the contents of the Certificates; copies of these are available on request from MiTek.

However, to give an insight into the method of joint design using the nailplates, the Designer should note that each nailplate joint must be assessed for shear

strength and lateral resistance to the forces placed upon its integral teeth.

The values for shear and tensile strength are given in the relevant Certificate, as are the values for the nail anchorage loads. It should be noted that the lateral resistance of a nailplate joint depends upon:

1. The number of effective nails in the joint.
2. The species of timber used and its condition (moisture content).
3. The duration of the loading applied.
4. The direction of bearing of the nails in relation to the grain of the timber (load to grain).
5. The direction of the loading in relation to the connector plate (load to nail).

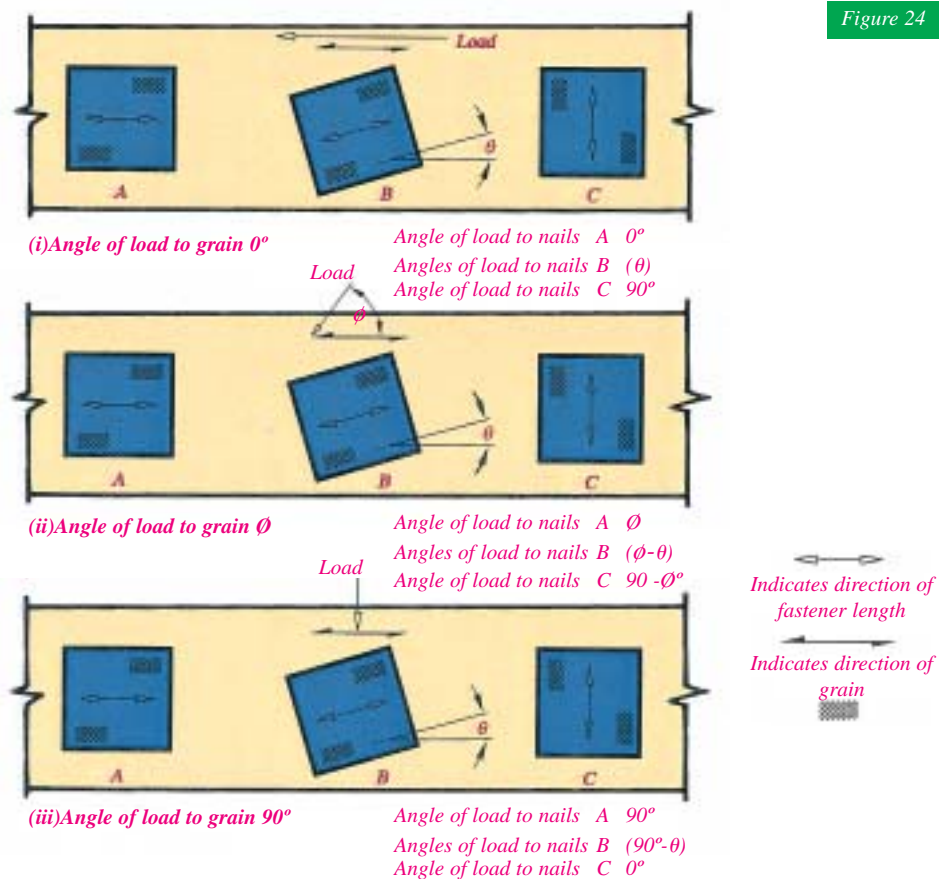

Figure 24

It should be noted that, when designing a nailplate joint, the approval Certificates define certain ineffective areas at the ends and edges of the timber in which the nails are to be ignored for the design.

Further, the species of timber used and the duration of loading causing the forces must be taken into account.

Finally, the actual position of the nailplate on the joint will affect the permitted values for each nail.

It can be seen that this leads to a highly complex interaction, as several different load durations, combined with a number of possible nailplate orientations and a large number of available sizes of nailplate makes the most economical choice of any particular nailplate a difficult decision.

By its nature, the solution of this interaction is now largely handled by MiTek's sophisticated computer programs although manual design is still necessary for very special applications.

Design Method

Splice Joints

Due to the need to make long span trusses from shorter lengths of timber, butt joints called SPLICES often need to be introduced in the top and bottom chord members.

between 10% and 25% of the panel length in which the splice occurs for triangulated trussed rafters. In other frames and when splices are outside of the code 'zone' the software will design the splice to resist shear, axial and moment forces.

These joints, like all other nailplate joints, need to be properly designed in accordance with the above factors. Splice joints will normally occur in positions

Some typical joint details are given in figure 25.

Figure 25

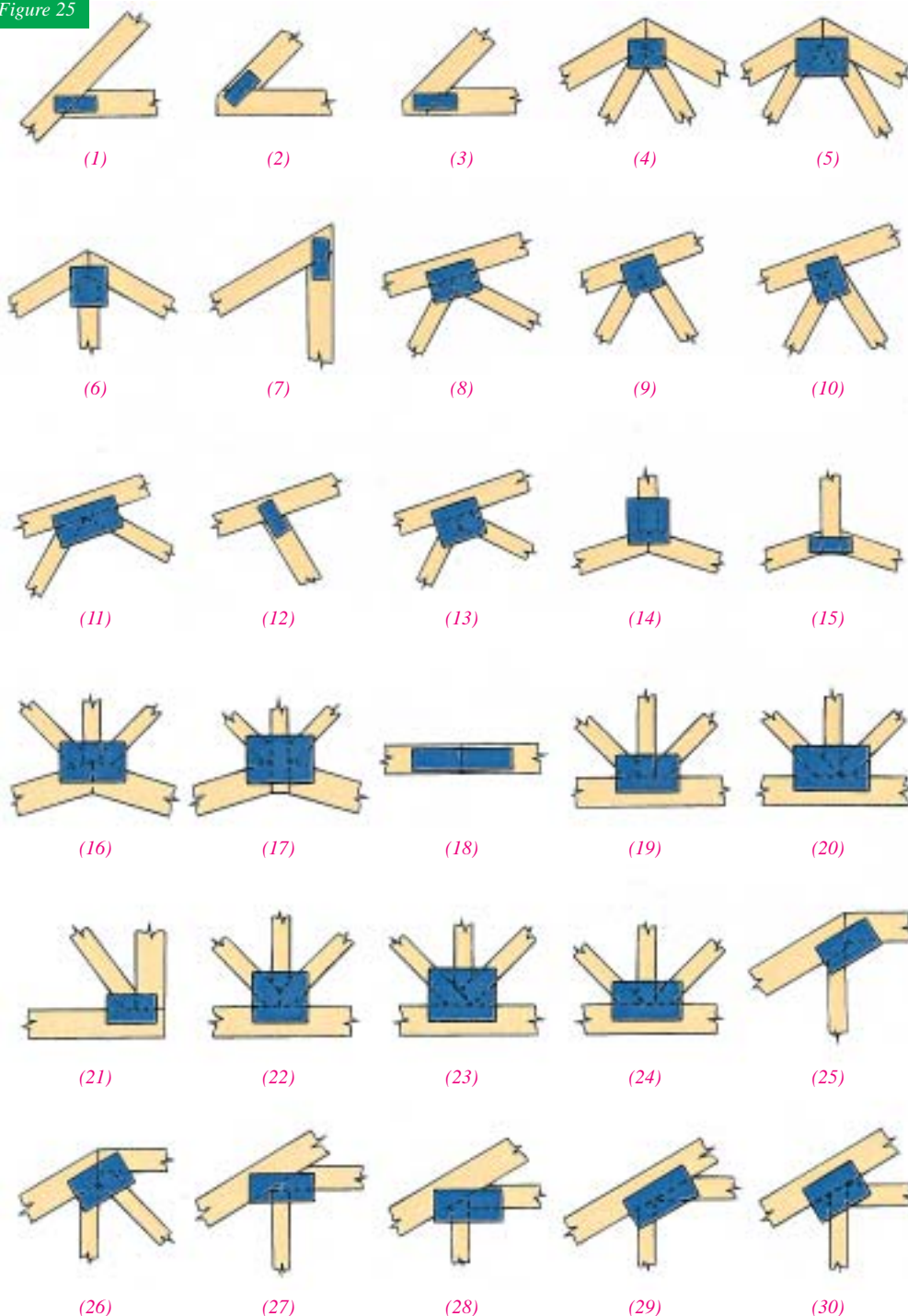

Roof and Trussed Rafter Bracing

Bracing in trussed rafter roofs is essential and performs specific and separate functions:

1. TEMPORARY BRACING

Temporary bracing is required during erection of the trussed rafters to ensure that the trusses are erected vertically plumb, at the correct centres and in a stable condition for the continuation of construction.

This bracing is the responsibility of the roof erector, (see later for recommendations).

TRUSS INTEGRITY BRACING (Specified by Trussed rafter Designer)

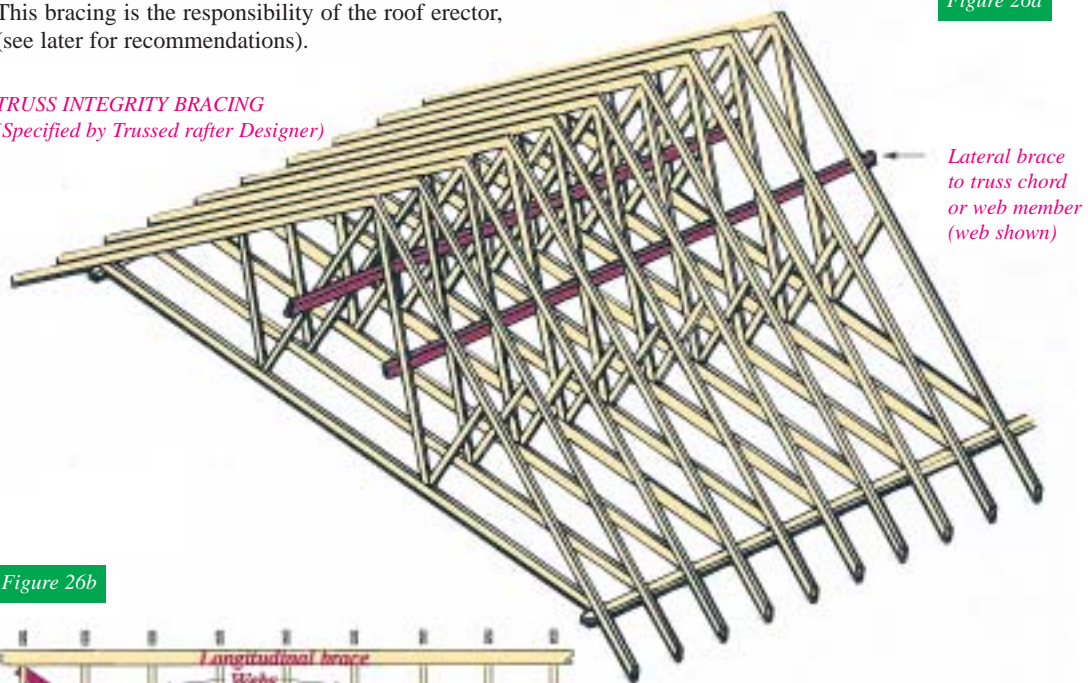
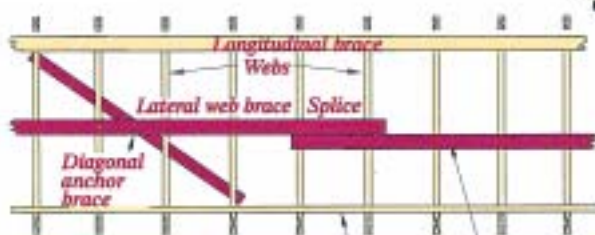

Figure 26a

Figure 26b



LATERAL WEB BRACING

One shown (with splice) at mid point of webs. For two braces, locate at third-point of webs. Diagonal anchor braces as shown at 6m intervals. All braces 25 x 100 free of major defects and fixed with two 3.35 x 65mm galvanised nails at all cross-overs.

3. ROOF STABILITY BRACING

In addition to the above bracing, extra bracing will often be required to withstand external and internal wind forces on the walls and roof. This area of bracing design is the responsibility of the Building Designer (or Roof Designer if one has been appointed) and includes such areas as diagonal wind bracing, chevron bracing to internal members, longitudinal bracing at truss node points, etc.

2. TRUSS INTEGRITY BRACING

Bracing may be required by the trussed rafter design to prevent out-of-plane buckling of a member or members within the truss. This bracing must be provided to ensure the structural integrity of the trussed rafter. It is the responsibility of the Trussed Rafter Designer to inform the building designer if this is required.

See figure 26a, 26b and 26c.

Figure 26c

ALTERNATIVE WEB STABILITY BRACE (use when less than three trusses in line)

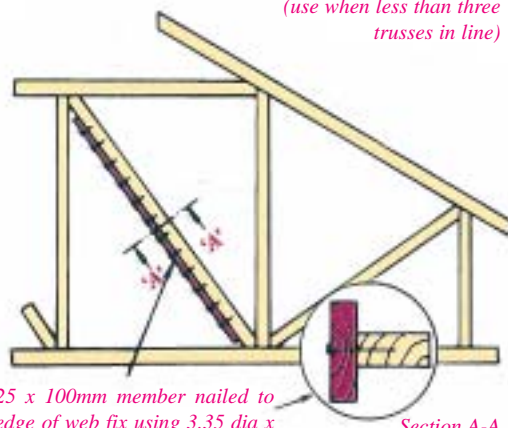

25 x 100mm member nailed to edge of web fix using 3.35 dia x 65mm long R/W galvanised nails, at 150mm centres.

Roof and Trussed Rafter Bracing

BS.5268-3 gives some recommendations for certain specific cases of roofs; for other types of roof the bracing pattern for roof stability should be designed by a competent person. See figure 27a, 27b, 27c and 27d.

Figure 27a

(Specified by the building or roof designer) for guidance only please refer to BS5268-3.

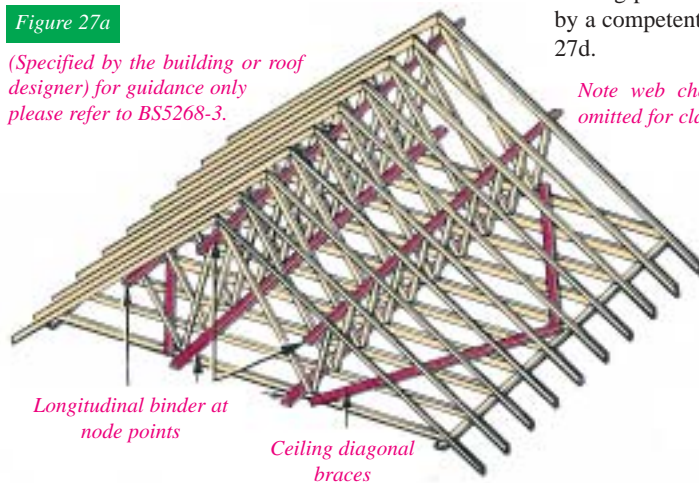

Note web chevron and rafter diagonal bracing omitted for clarity, see following details.

Figure 27b



Figure 27c

RAFTER DIAGONAL BRACING

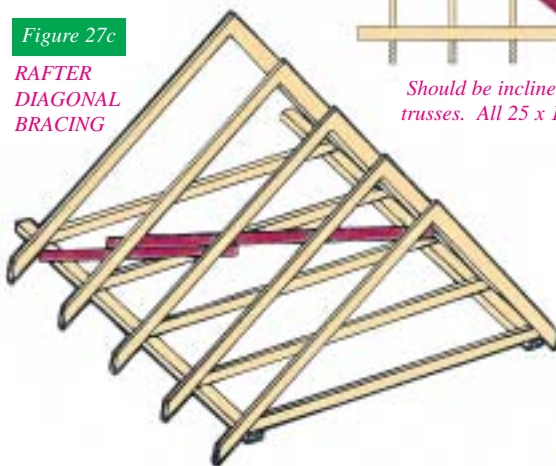

Should be inclined at approximately 45° and each nailed to at least three trusses. All 25 x 100mm free of major defects and fixed with 3.35 x 65mm galvanised nails at all cross-overs.

Figure 27d

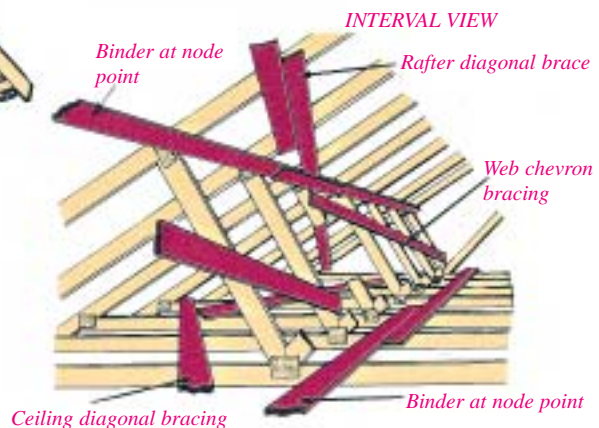

(One only shown and spliced) webs and all other bracing omitted for clarity. Braces to be 25 x 100mm free of all major defects and fixed with two 3.35 x 65mm galvanized nails at all cross-overs including wall plate. Braces to be included at approximately 45° to the tiling battens and repeat continuously along the roof.

Design responsibility

Specifiers and designers should understand that Truss integrity bracing is the responsibility of the Trussed Rafter Designer who must inform the Building Designer if such bracing is required. Whereas Roof Stability bracing (and any additional specialist bracing) is the responsibility of the Building Designer (or Roof Designer if one has been appointed). The Building Designer is responsible for detailing ALL bracing.

The Building Designer has access to information pertinent to the structure i.e. walls, and the forces being transferred from them, which the Trussed Rafter Designer cannot determine. (See also section 1.2 on Design Responsibilities).

Please refer to BS 5268-3 for further guidance on bracing of roofs for domestic situations.

Loading and Load Cases

It is important that all truss loadings are specified before quotation to ensure correct design. Unless

otherwise advised, trusses will normally be assumed to be for normal domestic use.

Loadings for Domestic Use

The great majority of trusses fall into this category. The relevant document, BS 5268-3 describes the minimum loadings which should be taken into account.

The following data provides a useful guide to typical loading factors in roof design:

TOP CHORD (Rafter)

Tiles

Weight to be as laid. Nearly all commonly used interlocking concrete tiles are within 0.575kN/m^2 , which is regarded as the standard loading. It is important that the actual tile weight to be used is notified to the Trussed Rafter Designer. This loading is specified as a long term loading on slope; i.e. applied along the length of the sloping rafter.

Felt, Battens, Self Weight

The allowance usually made for felt, battens and self weight of trusses is 0.11kN/m^2 .

As are the tiles, this is regarded as a long term loading slope.

Wind

Except in the case of vertical and near vertical chords, wind loading is not often a critical criterion in the design of fully triangulated trusses.

All trusses should be designed for wind loading in accordance with BS 6399: Part 2 code of practice for wind loads. Wind load data should be provided by the Building Designer to the Trussed Rafter Designer.

Wind loading is treated as a very short term loading, applied at right angles to the relevant members.

Snow

Designs for snow loadings are in accordance with BS 6399: Part 3: Actual design loads are dependant upon several factors, such as building location, altitude and roof plane geometry. The loadings imposed by snow are regarded as medium term loadings, on slope. Where appropriate, snow drifting should be considered.

Man Load on Rafter

This is specified as $0.75 \times 0.9\text{kN}$ in any position. Test have shown that, in normal circumstances, tiles and battens provide sufficient transverse load distribution for this loading not to be a critical criterion in design. However it can dictate the design of a long overhang. This loading is treated as short term loading.

BOTTOM CHORD (Ceiling Tie)

Plasterboard, Self Weight etc

The standard ceiling construction of one layer of 12.5mm plasterboard and skim coat is taken as giving a load of 0.25kN/m^2 (including truss self weight).

This load is treated as a long term loading on slope (although generally bottom chords will have no slope).

Light Storage

For normal domestic applications, the specified allowance for storage over the length of the bottom chord (ceiling tie) is given as 0.25kN/m^2 (on slope). For anything other than this condition, the Building Designer should inform the Trussed Rafter Designer of the required storage loads to be used.

This load, as for the ceiling construction load, is treated as a long term loading on slope.

Man Load on Ceiling Tie

To allow for loadings imposed by a person working in the roof void, an allowance of $0.75 \times 0.9\text{kN}$ at any location on the bottom chord, either in the bays or at the node points (joints) should be made. This loading is treated as short term loading.

Loading and Load Cases

Loadings - Water Tank

Water tanks in trussed rafter roofs should be supported by a system of bearers and cross-bearers in such a fashion that the loadings imposed on the trusses are transferred to a position as close as possible to the node points (joints) of the trusses. The standard 230 litre water tank is usually supported over three individual trusses, or 300 litre tank over four trusses. The long term loading from this arrangement is taken as 0.9kN/truss (0.45kN per node).

Loadings - Agricultural Buildings

Loadings for agricultural buildings are described in BS 5502 and are based on weight of the actual materials in the fabric of the building. Snow and wind loading criteria depend on occupancy classification determining the acceptability of collapse and expected life of the building.

Compliance with BS 5502 has been a condition of obtaining certain capital grants and an up-to-date briefing on the matter should be obtained before specification.

Purlins

Trussed rafters are generally used in conjunction with tiling battens fixed to the upper edge of the top chords and this provides an excellent method of out-of-plane restraint to the top chords. If tiling battens are not to be used, it is vital to specify the maximum purlin spacing to be used for two reasons:

- 1.To allow the Trussed Rafter Designer to apply the loads in the correct way.
- 2.To allow the Trussed Rafter Designer to apply correct top chord restraints.

The Trussed Rafter Designer will require this information in order to obtain a correct design.

Load Duration (load cases)

The load-carrying characteristics of timber are such that it can sustain heavier loading for a short time than it can for a long time.

This effect is used in establishing the allowable structural properties of a particular timber grade (or Strength Class).

Trussed rafters and other structural timber components are then designed taking into account the differing durations of the various loadings which they are required to carry.

The main loadings encountered in dealing with trussed rafters (see earlier in this section) are:

1.Roof Coverings:

Tiles, slates etc. are considered as long terms loads, as they will be present throughout the life of the building.

2.Ceiling Construction:

Plasterboard etc at ceiling level is, like the roof covering, considered as long term.

3.Ceiling Storage:

The allowance for storage in the roof void at ceiling level is also treated as an ever-present, long term load.

4.Water Tanks:

As these will also be present throughout the building's life loads applied by water tanks are treated as long term loads.

5.Snow Loadings:

The design allowances for loadings due to snow on the roof are treated as medium term loads, i.e. these loads will not be present at all times, but will affect the roof structure only for a period of weeks or months at a time.

6.Man Load on Rafter and Ceiling:

Where this is applicable, this load is treated as a short term load, ie this load will be present within the structure for a period of minutes or hours only.

7.Wind Loadings:

Always considered for design, the loadings due to wind are treated as very short term loads. These loads will be present on the structure for a period of minutes or seconds only.

The above loadings cover the most usual types of load carried by trussed rafters.

Other loads may be present within the roof in special circumstances These may include air conditioning equipment, patient hoists, climbing ropes etc and must be allowed for in the design, in the appropriate load case.

Loading and Load Cases

The load cases which normally dictate the results are:-

1. Long Term

Designing for the effect of all long term loads (all loads which will be present throughout the life of the building) i.e.:

- Roof coverings
- Ceiling constructions
- Ceiling storage
- Water tanks
- any special long term loads.

Figure 28a

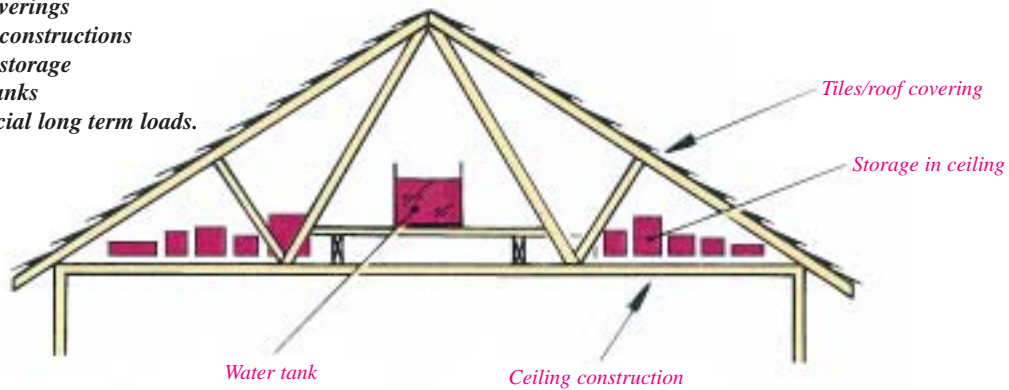

2. Medium Term

Taking into account loads which will be present for a period of weeks or months on the building i.e.: - *All the long term loads Plus - snow loads*

Figure 28b

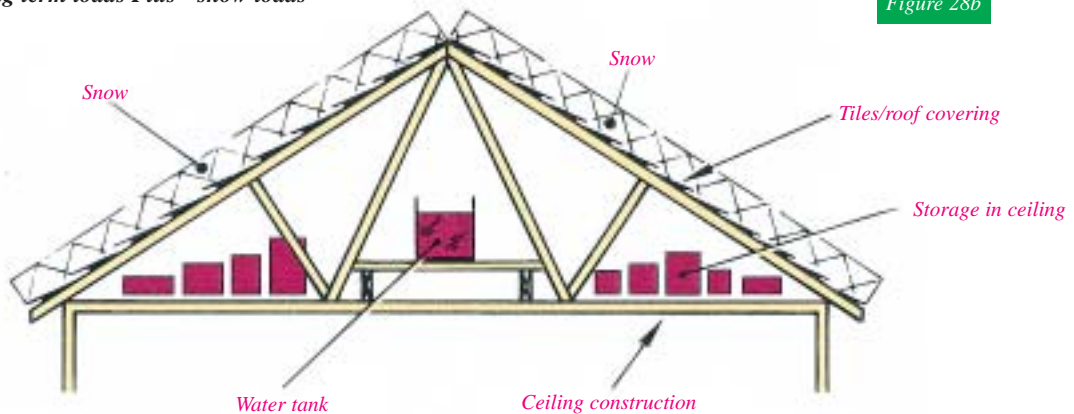

3. Short Term

For loads which may occur for minutes or hours during the buildings life i.e.:

- All the long term loads
- Plus - Snow loads
- Plus - The man load on the bottom chord

It will be seen that this load case will, in fact, be a multiple load case as the man load must be checked at every bottom chord bay and node position. Note the man load on top and bottom chords are in separate load cases.

Figure 28c

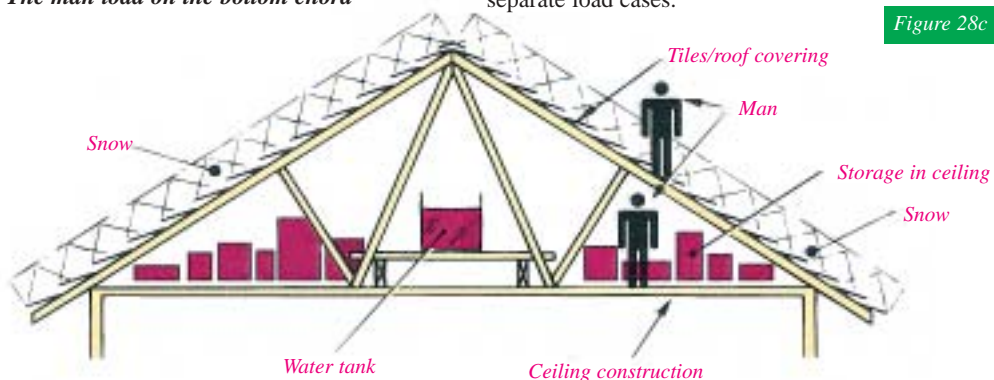

Full details of load cases see BS 5268-3

Selecting Trussed Rafter Profiles

Determination of the required truss rafter profile assumes the ability to read a two dimensional drawing and visualise the required structure in three dimensions.

This skill is acquired by experience, although certain powerful graphical aids in the form of computer programs are now available to assist the designer in this area.

The designer's task is to take the roof plans, sections and elevations presented to him by his client and form the required roof shape in his mind. The technique of 'sectioning' the roof will then give the

required profile of the truss required at any point.

'Sectioning' requires the designer to consider the height dimension of a particular point on the roof line, as well as its plan position. The profile change points for a truss are often seen on the roof plan as hip or valley intersection lines, or at points where the apex or eaves line changes in some respect.

The following figures illustrate the transition from two-dimensional roof plan to three-dimensional impression of the roofscape to the required trussed rafter profiles.

ROOF PLAN

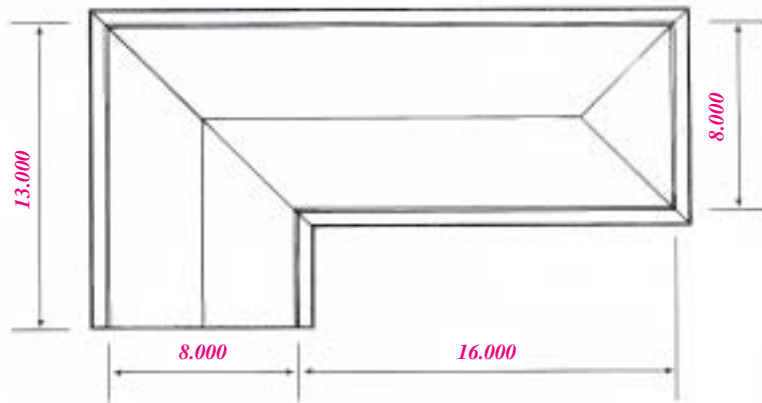

Figure 29a

Figure 29b

THREE DIMENSIONAL REPRESENTATION OF ROOF

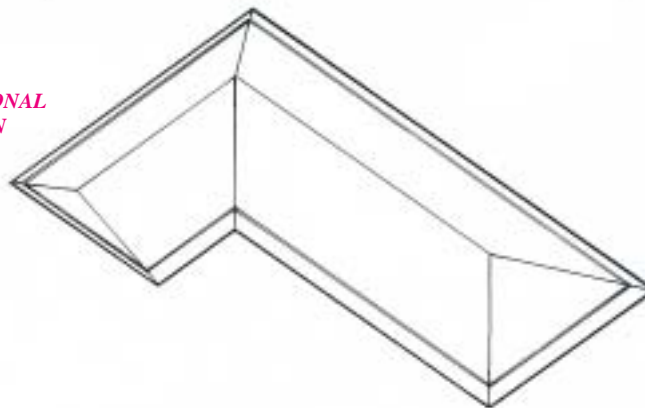
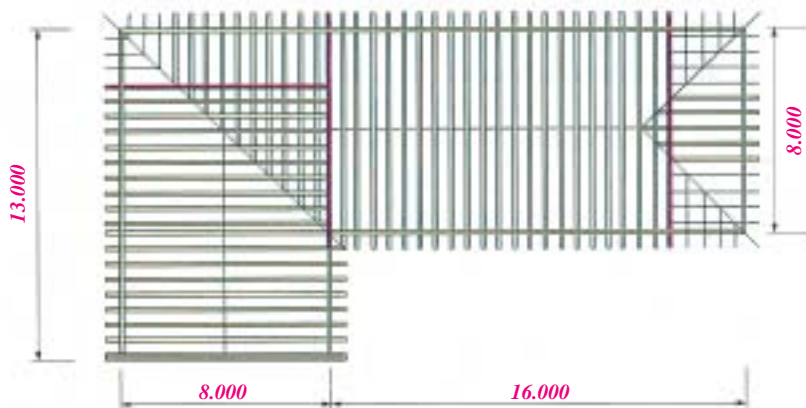

Figure 29c

FRAMING PLAN



Selecting Trussed Rafter Profiles

Figure 30a

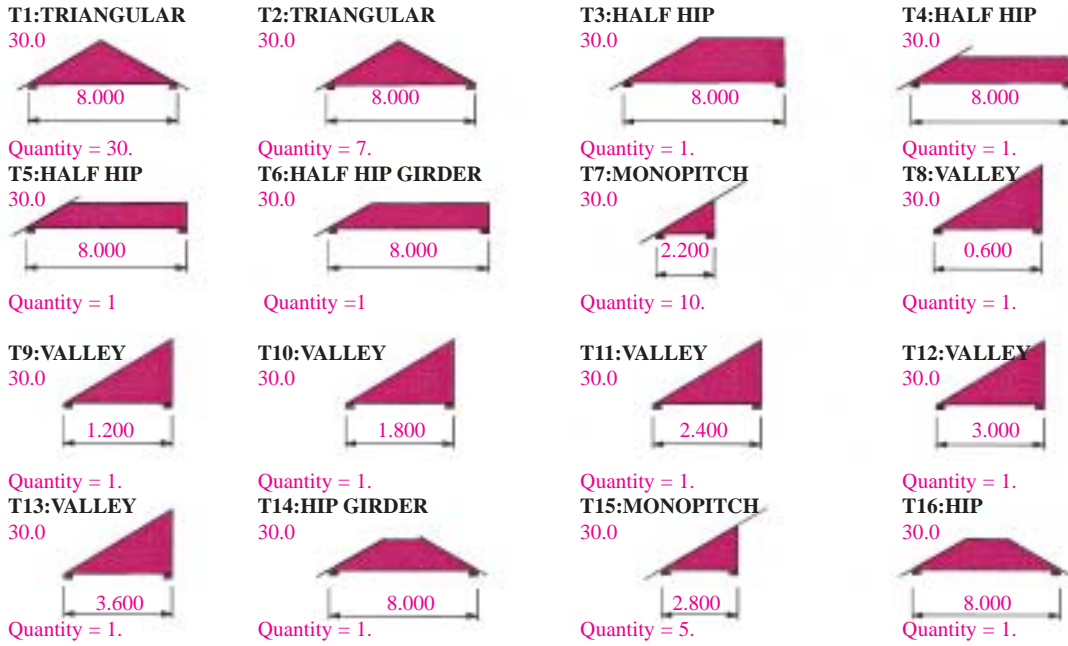

Another illustration of 'sectioning' to find the required profile would be the choice of either a cantilevered or

bobtail truss, as shown in the following figures.

Figure 30b

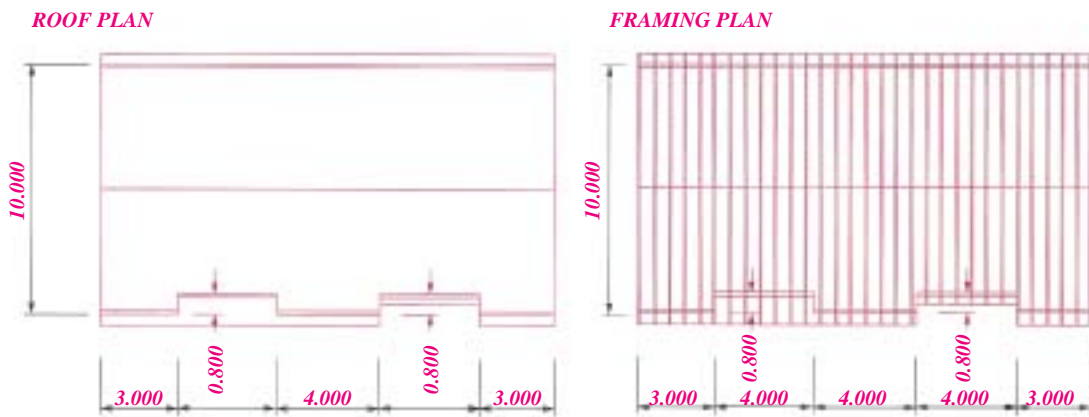

Figure 30c

As mentioned earlier, computer graphic programs are increasingly assisting the designer to visualise the roofscape.

The figures in this section have been produced from MiTek's MI2000 layout, take off and design software.

Framing Common Roofscapes

Bobtail (Stub Ends)

Bobtail or stub-end trusses are used where the supporting wall position on one or both sides is set in from the normal heel position. (see section 3.9, bearing details). This commonly occurs where recesses occur in the outside wall line of a building or where walls are built up to tile level to provide a firebreak compartment within the building.

The horizontal 'A' dimension (figure 32), known as the cut-back, is therefore conveniently used to specify the shape for duo-pitch trusses, while double bobtailed trusses and bobtailed mono-pitched trusses are often more conveniently specified by a vertical 'A' dimension, known as the End Height.

Figure 31

EFFECT OF BOBTAIL ON ROOF LINE

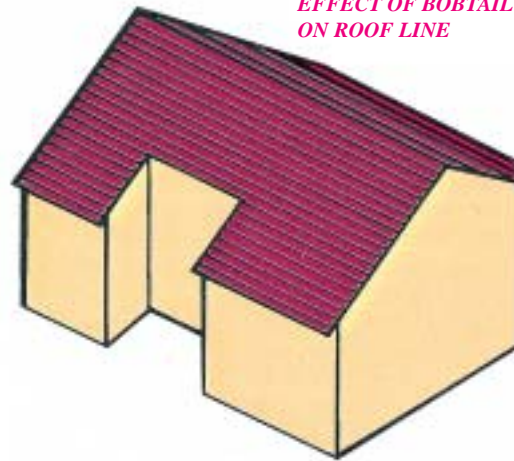

Figure 32

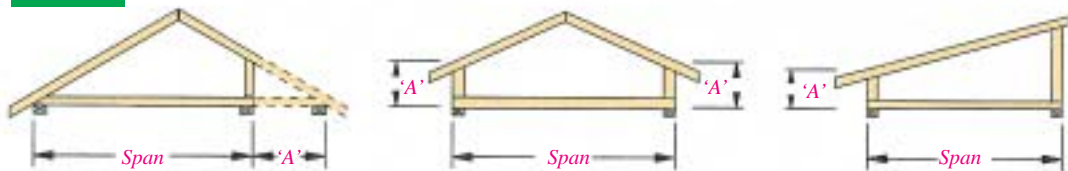

Figure 33 shows typical end details when the outer leaf is of masonry. Arrangement 33b is best confined to timber frame construction as separate columns of masonry between trusses could be unstable. There should be sufficient depth of masonry on figure 33a to anchor the roof down against wind uplift. If the end verticals are to be tile clad, one of the arrangements in figures 33c or d is suitable. In figure 33c a specially wide timber is used as the end vertical

of the trusses so that the tile battens clear the outer leaf of the wall; the inside of the end vertical member of the truss must not be located to the right of the centre-line of the wallplate. In some cases this arrangement is impractical owing to the large width required for the end vertical. In many cases the diagonal in the cantilevered part (figure 33d) can be omitted if there is little load from the cladding.

Figure 33a

MASONRY OUTER LEAF

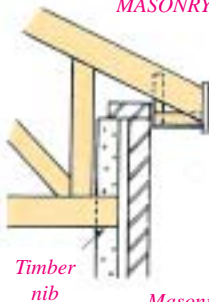
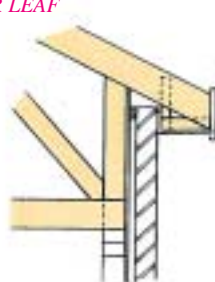

Figure 33b

Masonry inner leaf



Timber frame

Figure 33c

TILE CLAD END VERTICAL



Figure 33d

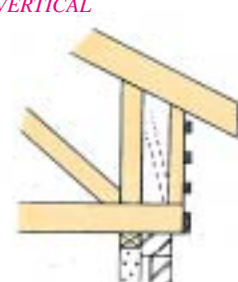

Bobtailed trusses must never be formed through on-site modifications of standard truss types with which they align, following the basic rule that a trussed

rafter should never be cut, notched, drilled or otherwise modified without first checking with the Trussed Rafter Designer.

Framing Common Roofscapes

Cantilevered Trusses

The reaction from the bearing is the greatest load (although upwards) to which a truss is subjected, and in order to control excessive bending in the supported chord, it is important, except in the smallest trusses, to locate a joint at each bearing. The normal eaves joint (figure 34a) accomplishes this if the bearing shift is less than one-third of the scarf length or is less than 50mm.

If the shift is greater than the allowed a stress check is required on the short cantilever. Unfortunately, there is often insufficient space for an additional web so it is usually necessary to increase the bottom chord (figure 34c) or alternatively, to incorporate a relief rafter (figure 34d) or a heel wedge. Both of these options can add to the final costs of the trusses and therefore it is best to avoid cantilevering the trusses in this range.

Figure 34a

Standard truss

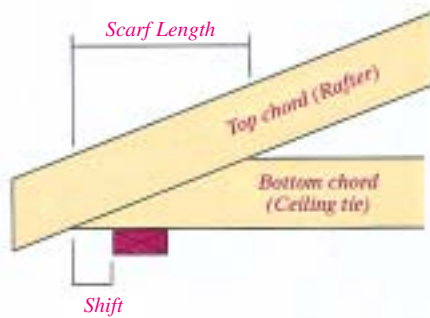
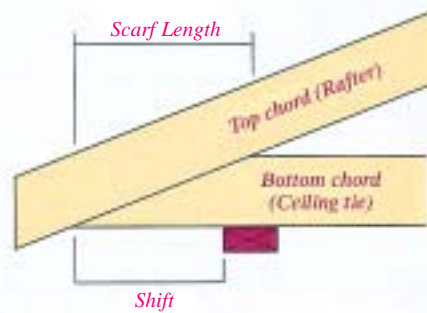

Figure 34b

Check bottom chord



If the shift is greater than two scarf lengths, then an ordinary standard cantilever truss is employed. (fig.35)

position of the joint on a non-cantilevered standard truss type, so that it is over a bearing.

Note that the chord sizes are not normally greater than the corresponding non-cantilevered standard truss and the cost is very little more. The MiTek system offers many standard cantilevered truss types. Many other variations are possible by adjusting the

Finally, if required a non-standard cantilever truss of almost any triangulated configuration can be designed and fabricated. Note that a brace may sometimes be needed on the bottom chord, which is untypically in compression.

Figure 34c



Figure 34d

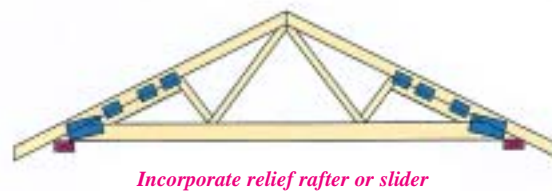
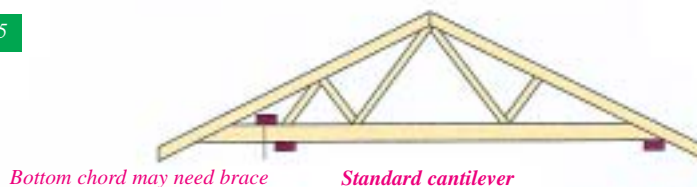

Figure 35



Framing Common Roofscapes

Typical Roof Features - Hipped Ends

The most common end shapes are the Gable End, which allows the simplest roof framing and uses most support wall surface; the Hipped End which offers a simple wall solution at the expense of a more

complex roof structure, and the Dutch Hip and Gable Hip, which are compromises between a gable and hip, easily formed using trussed rafters.

Figure 36a

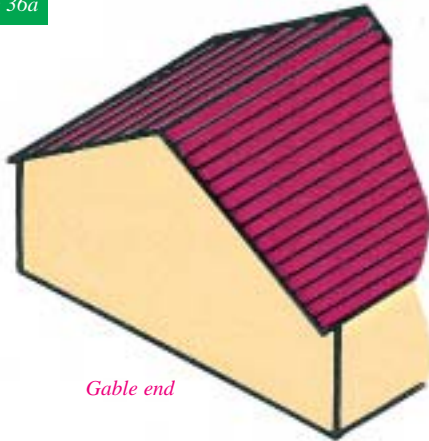

Gable end

Figure 36b

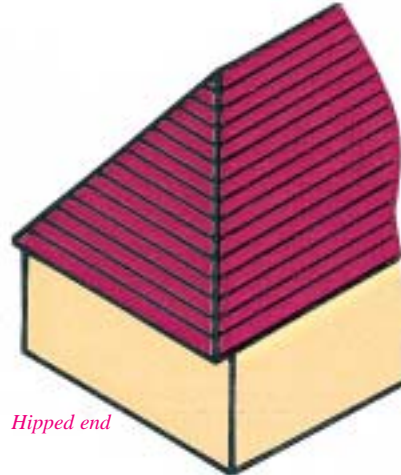

Hipped end

Figure 36c

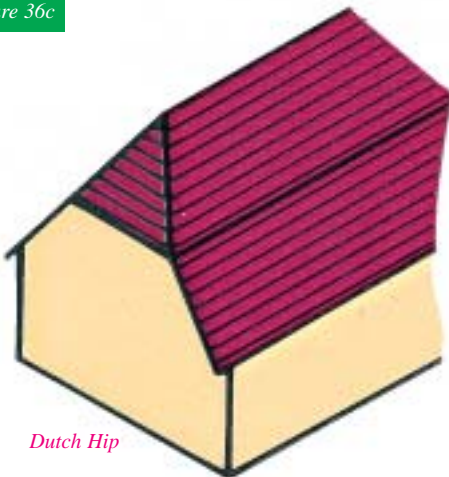

Dutch Hip

Figure 36d

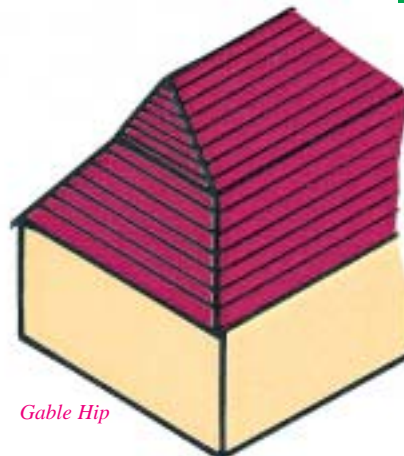

Gable Hip

Figure 37a



Action of hip end

Figure 37b



Traditional hipped end

Most traditional hipped ends behave like an inverted conical basket and, under load, the tendency for its rim (the wall plate) to spread is resisted by friction (lateral force on the wall), tension in the rim (tension and bending in the wall plate) and tension in the weft (the tiling battens). In the long term the results are sagging hip boards and rafters, bulging walls and characteristic horizontal cracks in the masonry at the inside corners of the dwellings roughly 300-600mm below ceiling level.

However, hipped end systems develop by MiTek do not depend on tension in battens, or a massive wallplate and horizontal resistance from the walls. With suitable bracing, the trussed rafter hip roof provides the walls with the stability required by Building Regulations.

Framing Common Roofscapes

Hipped Ends

The simplest form of hipped end consists of a multi-ply girder of standard trusses securely nailed or bolted together, which support loose rafters and ceiling joists, as in figure 38.

This is the most inexpensive form of hip because no special trusses are needed other than the girder, but their use is limited to spans up to 5m.

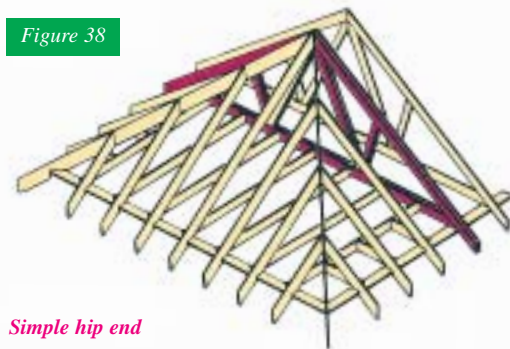

Loose rafter and ceiling joist sizes should be taken from Approved Document A to the Building Regulations. Hip boards should be supported off the girder by means of a ledger. The ceiling joists should be supported by proprietary joist hangers.

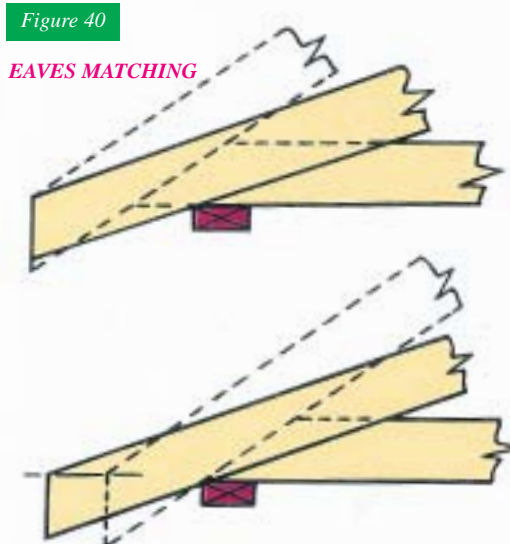
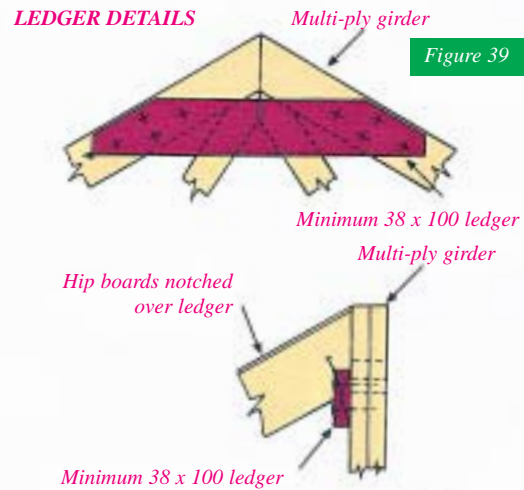

If the end pitch is different to the pitch of the main roof, the eaves details should be discussed with your trussed rafter supplier. It is advisable to ensure that the top extremities of rafter overhangs are at the same level to provide for continuous guttering. Note that whilst adjustments can be dealt with on site in loose timber construction, the mono-pitched trusses used in other hip types must be made correctly in the factory.

It should also be noted that all forms of hip construction employing a hip board exerts a horizontal thrust at the wallplate corner junction. Having taken up any horizontal movement, of course, the structure becomes stable. Movement of the wallplate can be controlled by fixing a 1200mm length of galvanised steel restraint strap around the outside. See figure 41.

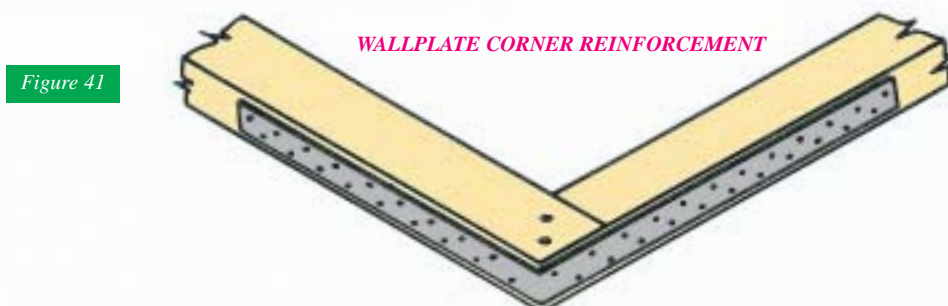

MiTek trussed rafter suppliers can provide detailed advice on hipped end roof details.

Framing Common Roofscapes

Hipped Ends - 'Stepdown'

The step-down hip system uses flat top hip trusses of progressively diminishing height from the ridge to the girder truss position. This system is rarely used as each truss is different to make. The number of step-down hip trusses is determined by the need to maintain reasonable sizes for the loose ceiling joists and hip board in the hipped corner infill areas. For these reasons, the span of mono-pitch trusses is not usually greater than 3 metres in the case of regular hips, where the hip end pitch is the same as the pitch of the main roof.

hip truss to support tiling battens. The web configuration of the various truss types shown (including the mono-pitch) are typical, but will be chosen to provide the best structural solution. Fortunately, this system is flexible in accommodating large spans and irregular hips with unequal roof pitches and employs standard, designed truss types throughout.

Noggings must be fitted between the flat chords of the step-down

Figure 42

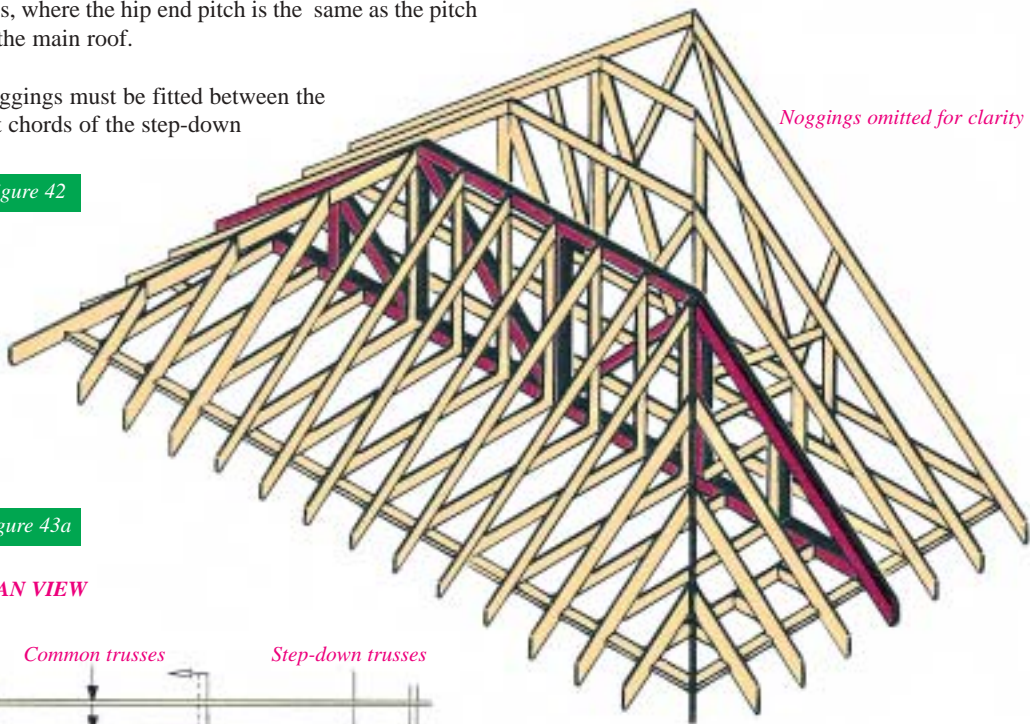

Figure 43a

PLAN VIEW

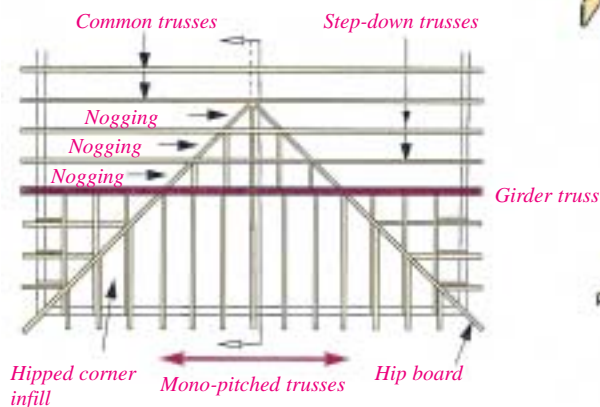

Figure 43b

SECTION

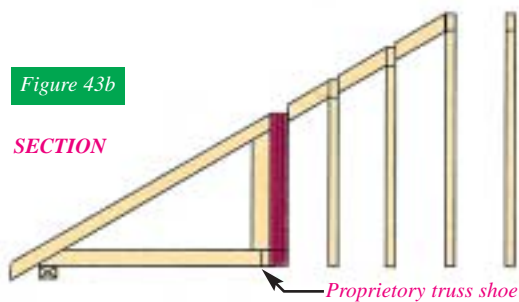
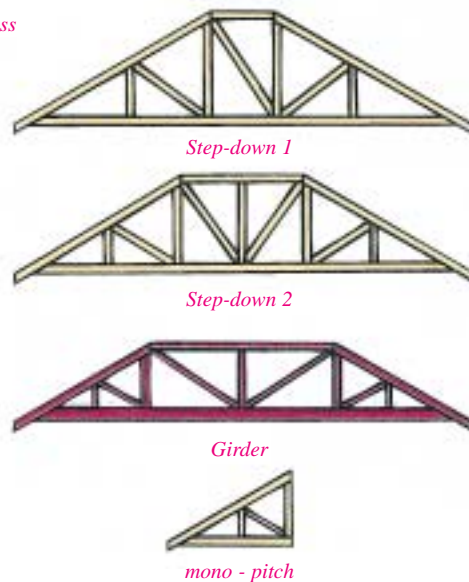

Figure 43c

TRUSS COMPONENTS



Framing Common Roofscapes

Hipped Ends - 'Flying Rafter'

Of the many types of hip systems this one has an obvious manufacturing advantage: There is only one basic hip truss profile. All the hip trusses, including those forming the girder truss are identical; and the mono-pitch trusses supported off the girder have the same profile as the sloped part of the hip trusses, which speeds up fabrication and reduces the overall cost of the hip system.

The rafters of the mono-pitched trusses and/or hip trusses are extended and are site cut to fit against the upper hip board. Off-cuts may be required to be nailed in position to the rafters of the hip trusses. For the longer rafters props may be required to run down to the trusses underneath.

The flat parts of the top chords of the hip trusses and girder must be securely braced together to ensure stability.

The hip corner may be constructed from pre-fabricated rafter/joist components commonly called Open Jacks or all the corner can be framed with loose rafters, joists and hipboards on site. The hip board is notched over the girder truss and supported off ledgers at the apex of the hip.

This system offers the advantage of continuous rafters and thus easily constructed smooth roof slopes.

Typical spans using this construction with one primary multi-ply hip girder is 5 - 9.6 metres.

Larger spans, up to 13.2 metres, may be accommodated by the use of intermediate girders between the main girder carrying the mono-pitch trusses and the hip apex.

It is possible to construct several types of hip end using the *'Flying Rafter'* concept, or indeed, to combine the *'Step-down'* concept within the hip trusses with the *'Flying Rafters'* on the hip end mono-pitch trusses.

Please contact your truss supplier if you have a preference for a particular method of construction, as the MiTek design system can encompass any method.

- 1 Flat top chords require bracing
- 2 Ledger under to support hip boards
- 3 'Flying Rafters' on hip trusses (may require props to trusses below)
- 4 Girder
- 5 Infill rafters
- 6 Hipboard
- 7 Infill ceiling joists
- 8 Mono-pitch trusses

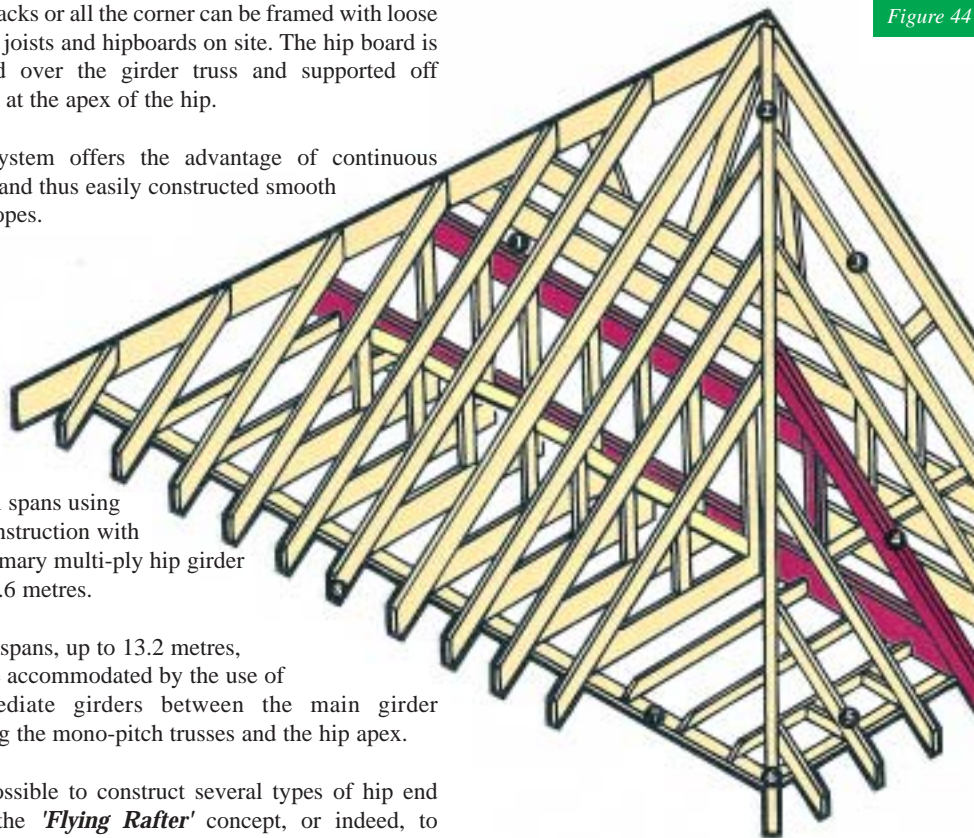

Figure 44

Rafters omitted for clarity

Framing Common Roofscapes

Hipped Corners

A hipped corner is formed by the intersection, at 90 degrees, of two roofs which may, or may not be the same span or pitch.

Figure 45

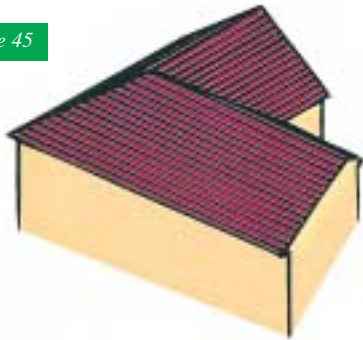

Hipped corners for mono-pitched and other roof shapes are based on the same principles described below for duo-pitched roofs.

The common framing consist of a SECONDARY half-hip girder truss supported by a PRIMARY duo-pitch girder truss. An internal load-bearing wall or beam support can often be used to perform the function of the primary girder truss.

The duo-pitch girder truss is specially designed for the exceptional loads it carries and includes a wider than normal vertical web to which a proprietary girder hanger can be fixed to carry the half-hip girder.

Figure 46b

PLAN VIEW

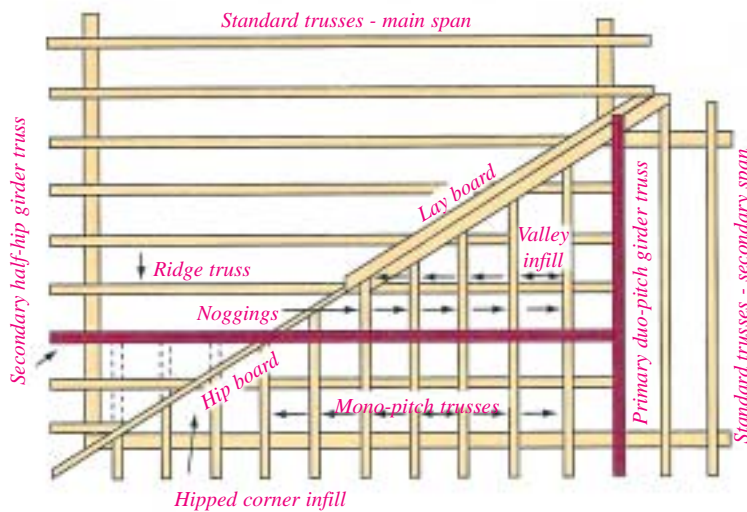

The roof is built up in the valley area using a mono-pitched valley set so that the half-hip girder carries the mono-pitch trusses and hipped corner infill, in the same way as at a hipped end. The span of the mono-pitch trusses is not generally greater than 3 metres and more than one half-hip truss may be needed between the ridge truss and the half-hip girder.

Figure 46a

COMPONENTS OF HIPPED CORNER

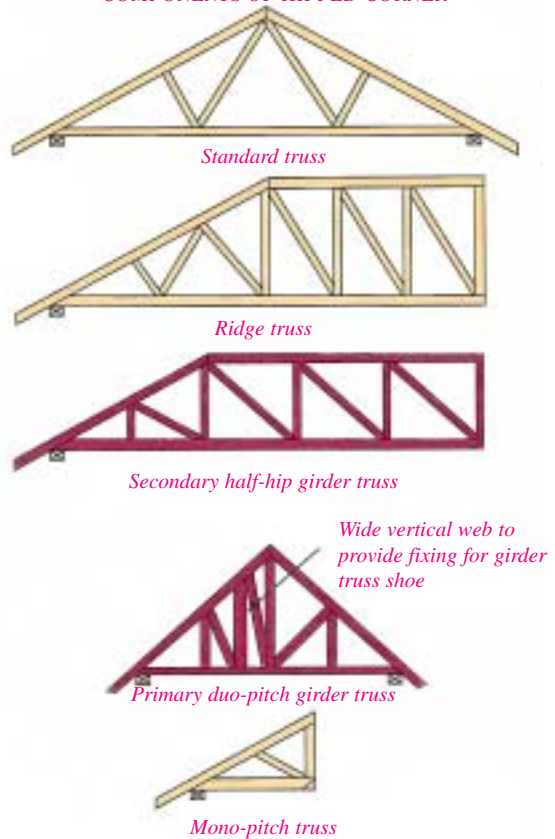

The details shown correspond to the method of construction used in the Step-down hipped end, in which noggings have to be sited between trusses to support the tiling battens.

Hipped corners with a Flying Rafter can also be provided.

Framing Common Roofscapes

'Tee' Intersections and Valley Infill

The basic junction of two roofs is known as a 'Tee' intersection, where a valley line will be formed at the point of intersection of the two sloping planes. The construction around the valley area is commonly formed by the use of either timber rafters, valleyboards and ridgeboards (not recommended) or by the use of pre-fabricated valley frames (Fig 47b).

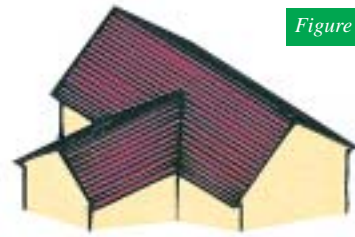

Figure 47a

Figure 47b



It is strongly recommended that valley frames be used in junction areas, as these provide the quickest, cheapest and most structurally effective solution to the roof framing in these areas.

The use and function of the valley frames are more important than they appear. The individual components transfer the roof loadings to the top chords of the underlying standard trusses in a uniform manner. Acting with the tiling batten between each neighbouring pair of components, they provide lateral stability to the same chords.

Some variations on the basic system are shown in figure 49. Others occur from time to time and suitable layouts can be easily devised by MiTek trussed rafter suppliers.

The layboards shown in figure 48 are in short lengths and supported off battens nailed to the sides of the rafters, to lie flush with the tops of the rafters. This enables the felt and tiling battens to be carried through into the valley. The tile manufacturers advice should be sought to ensure correct tile and pitch suitability.

In many cases, the support for the main roof trusses may be provided by a multi-ply girder truss as shown in figure 48, with the incoming trusses supported in proprietary Girder Truss Shoes at each intersection.

It is common practice on site to erect the girder truss first and position the incoming trusses afterwards.

All MiTek girders are designed to resist stresses induced in the bottom chords by the supported trusses. The connector plates on girders will typically be considerably larger than those on the standard trussed rafters.

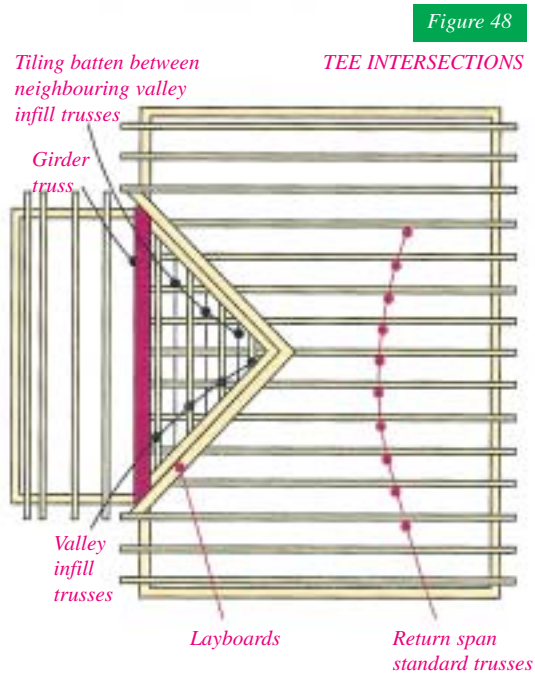

Figure 48

Figure 49



As described above, the valley construction should include intermediate tiling battens between neighbouring valley infill trusses, to provide the correct restraint for the rafters of the underlying trusses.

Figure 50



Framing Common Roofscapes

Dog Leg or Skew Corners

A dog leg or skew corner is formed by the intersection of two roofs at an angle other than 90 degrees.

It is usual for the incoming and outgoing roofs to have the same span and pitch, although it is possible to frame the roof using trussed rafters, if these differ.

The cross section may be of any of the usual shapes but is generally mono-pitched or duo-pitched.

Figure 51

DOG LEG



Figure 52a

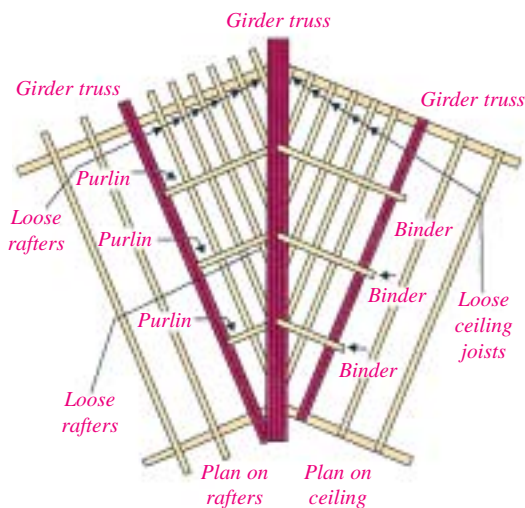

The typical framing plan shown for a duo-pitch roof is characterised by the minimum number of different truss types and provides a practical solution to the problems raised in these situations but using loose infill.

The multi-ply girders used have a number of vertical webs to allow the fixing of the loose timber purlins, which support loose timber rafters.

The example shown needs a lot of site loose work. However now that there are proprietary metal hangers available to join trusses to girders at angles other than 90 degrees the whole of the corner could be framed with trussed rafters.

Figure 52b

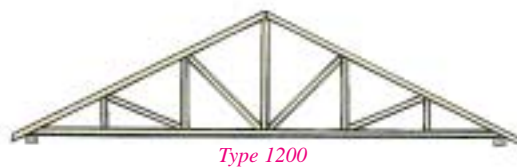
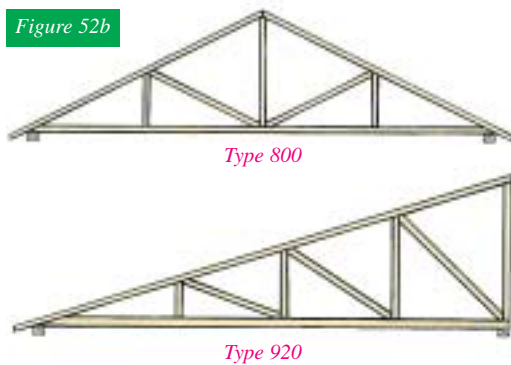
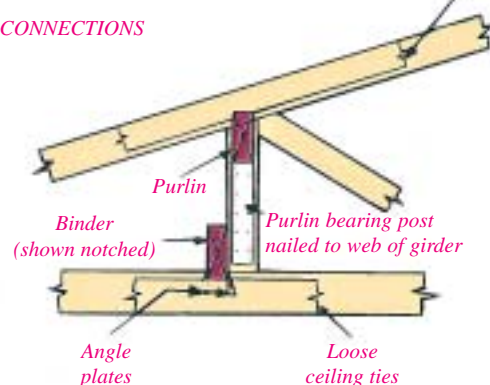

Figure 52c

Loose rafters notched onto purlin

CONNECTIONS



The feasibility of this framing method depends on the design of the longest purlin. Although installation of loose ceiling ties from girder to girder may be simpler in carpentry requirements, it is generally preferable to adopt the layout shown (incorporating loose timber binders at ceiling level), in order to simplify plasterboarding.

The ceiling binders should be supported on the bottom chords of the girders and located against the vertical webs. A robust structural connection for example, with two proprietary angle plates should be made between binders and loose ceiling joints. The ends of the binders may need to be notched or blocked-up off the girders, to ensure that the undersides of the loose joists are level with the girders.

Connection Details

Careful erection, fixing and strapping is essential if a trussed rafter roof is to provide a sound platform for roof coverings and contribute effectively to the stability of the roof and gable ends.

Strapping gables to ceiling ties

Ceiling tie straps may be excluded from the specification for roof pitches below 20 degrees. Check with the building designer. If they are needed, fix as shown for rafter straps, but attach to the upper edge of the ceiling tie. Use a twisted strap to engage a vertical joint if horizontal courses do not coincide.

Strapping at the separating wall

In addition to the normal strapping to walls, additional straps may have been specified to provide longitudinal bracing between roofs, these should be run over the top of the separating wall and fixed to the specified number of trusses on each side. Include noggings and packing to transmit loads properly.

Holding down roofs to walls

Roof to wall (vertical) strapping is not required unless the location of building construction is known to be wind stressed, then it is essential to carry out the roof designer's specifications. Lighter roof coverings in areas of higher wind load require holding down straps as may be specified for brick/block construction. In extreme cases the design may call for direct strapping of rafters to the walls (see figure 54).

Straps are normally 30 x 2.5mm section galvanised steel but any higher specification should be followed. The tops of the straps should be nailed (three 30 x 3.75mm nails or more) to the wall plate, or the rafter in the case of a rafter to wall strap. When fixing to the wall, it is critical that the straps are long enough to run over the specified number of blocks, and that at least two of the fixings engage the last full block at the base of the strap.

How to fix rafter straps

Engage at least three trusses with each strap. Use galvanised steel straps 30 x 5mm or approved profile galvanised steel straps.

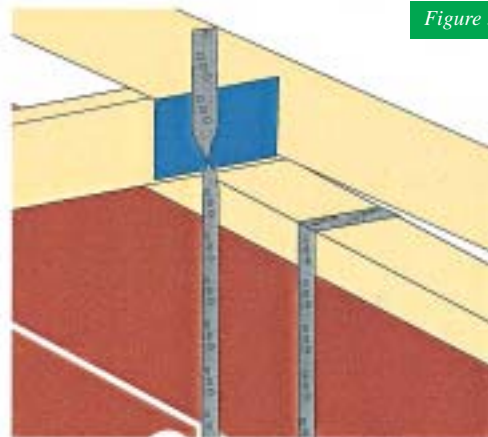
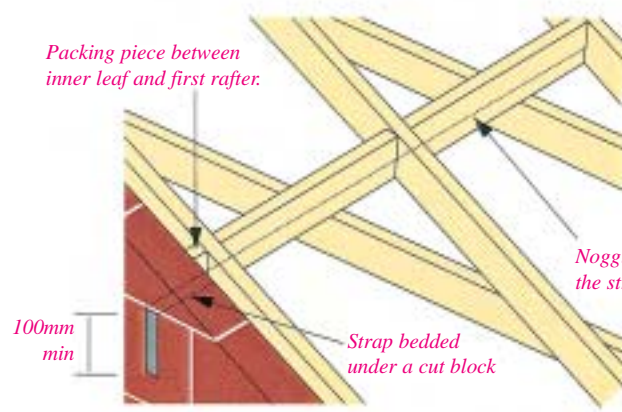

Figure 54

Figure 53



Packing piece between inner leaf and first rafter.

100mm min

Strap bedded under a cut block

Strap fixed to solid noggin with a minimum of four fixings of which at least one is to be in the third rafter or in a noggin beyond the third rafter

Use only corrosion resistant nails (65 x 3.35mm)

Noggings to be provided and set horizontal unless the strap has a twist to line it up with the roof slope.

Connection Details

Heavy-duty joist hanger to BS6178 Part 1

These are used to carry trusses or joists at masonry load bearing or fire break walls. Careful consideration must always be given to the method of support. We would recommend that advice is obtained from the responsible Building Designer or Structural Engineer since in a number of cases special hangers may have to be manufactured. The Building Designer may also specify high density brick courses above and below the hangers to avoid crushing of blocks. The bearing length for these joist hangers is approximately 90mm. (See figures 55 and 56).

Hanger for building into brick or block walls

Figure 55



Heavy-duty girder to girder truss shoes

These are designed to support a secondary girder off the main girder ensuring that the loads are transferred efficiently. The shoe is usually fixed to the main girder (A) by means of bolts as specified by the manufacturer with washers under the bolt heads and nuts. The bearing length for these shoes is approximately 120mm. (See figure 57). NB. Refer to manufacturers instructions for the correct application and procedure.

Figure 56



Straddle hanger for supporting joists either side of a wall or beam

Girder truss shoe and long legged hangers

Girder truss shoes are used to fix single trusses to compound girders or for other truss to truss connections. The bearing length is approximately 65mm.

The shoe or hanger must have side flanges of a size which suits the depth of the girder chord to which it is fixed. Some joist hangers are suitable only for timber or timber to truss connections not for truss to truss connections, always use the appropriate hanger. (See figure 58).

Figure 57

Incoming trusses supported by bolted heavy duty shoes and hangers, should be notched to provide a smooth ceiling line

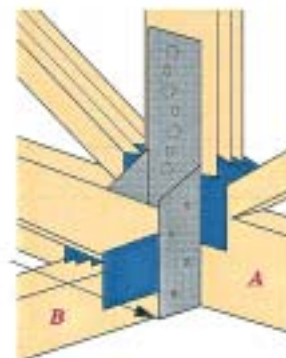

Metal fixings used in timber roof structures should have safe working loads which can be substantiated by freely available reports in accordance with BS6178 and TRADA recommendations. They should always have a manufacturer's mark and show the certified safe working load.

Figure 58

It is strongly recommended that timber to timber fixings and timber to brick fixings should be supplied by the Roof Truss Fabricator, and delivered to site with the trusses.

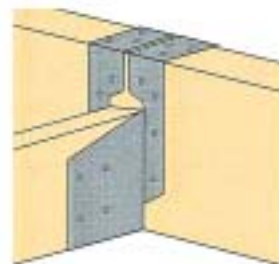

NB. For all the hangers and shoes described above, every fixing hole requires a 30 x 3.75mm square twisted sheradised nail unless otherwise specified by the manufacturer.

Connection Details

Raised Tie Support Clip (Glide Shoe)

This is a special application fixing that has been specifically designed to allow horizontal movement at a truss bearing without affecting the overall stability of the truss whilst continuing to provide resistance to lateral and uplift forces.

Used in trussed rafter roof construction the (medium term/long term) horizontal deflection should be restricted to a maximum of 6mm per side (truss bearing). A minimum 100mm horizontal seat cut must be made to fix the upper bearing plate. The lower bearing plate is fixed to the inner (or inner and outer) edge of the wallplate using 3.75 x 30mm square twisted sherardised nails.

The truss is temporarily secured by single nailing into the centre slots to allow lateral spread between the bearing plates after the roof structure is completed. The longer the period of construction lasts, together with the absolute stiffness of the truss configuration, the greater the lateral movement will be (up to the design limit). Finally additional nails should be inserted (3.75 c 30mm long square twisted sherardised) for stability or uplift resistance in the remaining fixing holes.

Figure 59

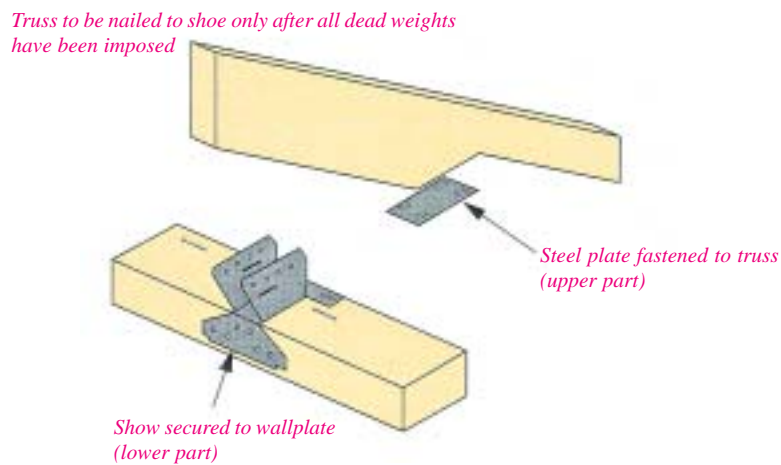

Connection Details

Figure 60

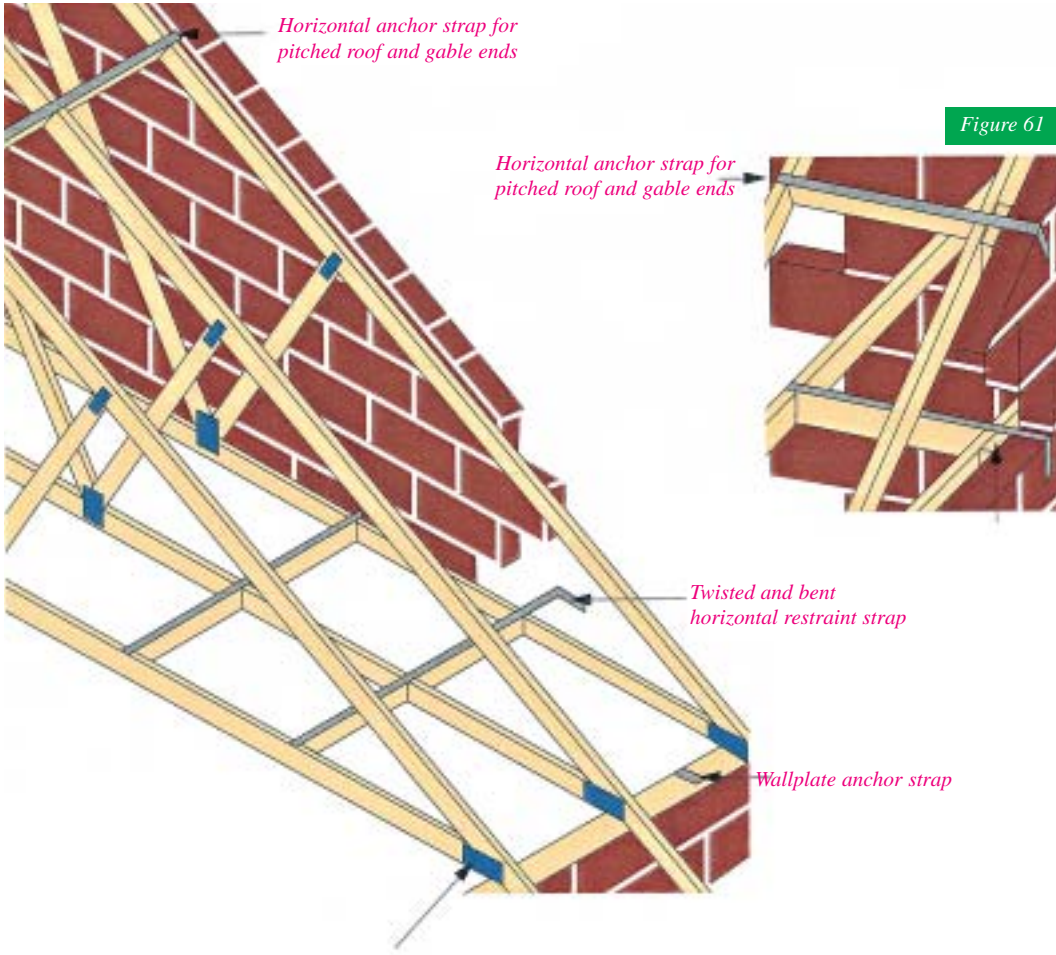
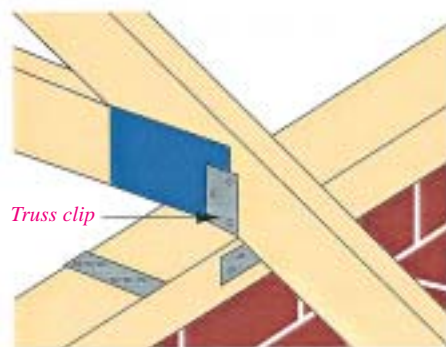

Figure 61



Truss clips are for fixing timber trusses to wallplates. They avoid the damage often caused by skew nailing. Follow the manufacturers recommendations for safe application of truss slip.

Figure 62



Problems to be aware of

Some of the more common problems which may occur when designing roofs containing trussed rafters are listed below.

1. Trussed rafter or frame?

Trussed rafters are fully triangulated frameworks and there is often confusion when raised tie or Attic frames are required. Such frames are not fully triangulated trusses rafters, although they are of similar appearance, and their design calls for a completely different approach than that for true trussed rafters.

Figure 63

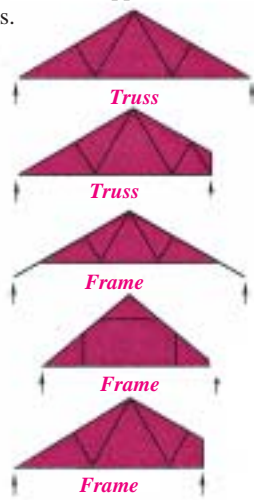

2. Trusses to match existing construction

Where trusses are required to align with existing roof constructions, great care must be taken to obtain the critical dimensions to which the new trusses should be made. The most common problems in this area are the misalignment of the outside rafter line and the mis-match of overall roof height.

Figure 64

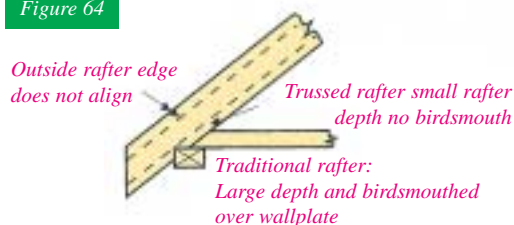

3. Changes in wall thickness

Trussed rafters are commonly supported on the inner leaf of a cavity wall construction. Where both inner and outer leaves of the masonry are required to support trusses (common when a garage abuts directly onto a bungalow for example), great care should be taken to ensure continuity of the outside rafter line.

Figure 65

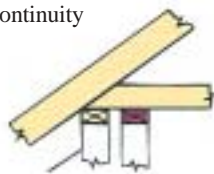

If trusses are supported on outer leaf (or single skin wall) some trusses may require short cantilever details

4. Changes in adjoining roof pitch

If two adjoining areas of roof are required to be at different pitches, care should be taken to ensure that the outside top edges of the rafter overhangs are of common height to provide continuity of fixing for fascia boards.

Figure 66

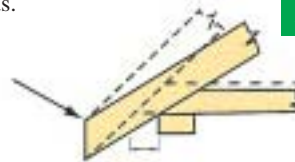

Cantilever produced by change of pitch

5. Variations in support conditions

It is increasingly common for the support conditions for trusses to be varied from the standard type of heel support, to create cantilevered and bobtailed (stub) trusses, where the cantilever or bobtail distance is short (in the order of 100 to 400mm). Such support conditions must be specially designed for. (See section 2.8).

6. Depth limits for trussed rafters

The general limit for the manufacture of roof trusses is in the order of 600mm overall depth minimum. Further, it is recommended that the span-to-depth ratio (span of truss divided by its overall depth) is not greater than 10. (See section 1.4).

7. Check that everything fits

Ensure that all water tanks, air-handling plant, services etc will fit within the outside profile and will clear the internal webs. A further point here, is to check that any deep hangers used to carry special loads will fit within the depth available to them, as such items tend to be relatively deep.

Figure 67

Tank does not fit



8. Fixings to support trusses

Timber to timber connections are best made at 90 degrees wherever possible, as angled connections increase costs. (See section 2.9).

9. Fixing of hangers

Where hangers are used on the bottom chords of girder trusses to support trusses and/or infill members, it is often more practical to provide a deeper bottom chord, usually 125mm or greater, in the girder truss to avoid the need for blocking-out on site.

Where hangers are used in masonry walls to carry trusses, a sufficient depth of masonry above the hanger should be provided to ensure a secure fixing. (See section 3.9).

10. Alignment of webs

In some cases, it is important to align webs on adjacent trusses within the roof to enable bracing members to continue in a straight line or for connections to be made from purlins. (See section 2.7).

Information for Site Use

Modifying Trussed Rafters on Site

The basis rule here is **DO NOT MODIFY TRUSSED RAFTERS** on site unless the prior permission for the modification is obtained from the Trussed Rafter Designer.

Trussed rafters are designed for a purpose and should never be cut, notched, drilled or otherwise modified without full consideration of the resultant effect.

If for some reason an adjustment in the geometry or internal structure of the truss is required by the site, **REFER BACK** to the Trussed Rafter Fabricator. He will have the engineering design for the units supplied and is in the ideal position to co-ordinate any action which may be needed.

Do's and Don'ts on Site

Site storage

Bearers should be placed on a level, hard and dry surface. A waterproof covering must be used to protect components against rain and sun and to allow good air circulation. In vertical storage, bearers must be high enough to keep rafter overhangs clear of the ground. In horizontal storage, bearers must be arranged at close centres to give level support.

Fit it right

Fixing problems are eliminated in roof construction by the use of proprietary Builder Products. Proprietary joist hangers, restraint straps, connector plates, framing anchors, truss clips and shoes save time, money and produce a quality job. Your MiTek fabricator will advise you as to the right products for the job.

Think don't cut

Trussed rafters are designed and fabricated for a particular purpose - and to save work. Trusses must not be cut under any circumstance. Truss spacings can usually be adjusted to take hatch openings and chimney breasts. For large chimney breasts, trusses are specially designed and supported. Don't cut or guess, consult your trussed rafter supplier if you are in doubt.

Handling

Care in the handling trusses must be taken at all times. 'See-sawing' trusses on walls or scaffolding must be avoided and where necessary an extra man should be used to prevent the truss being distorted. Large trusses handled mechanically should be adequately supported.

Bracing

The Building Designer will have detailed the permanent roof bracing. Permanent roof bracing is required to ensure the stability of the roof. Each roof requires longitudinal and diagonal bracing. In specific cases bracing is also required to stabilise long web members. Temporary bracing must be fixed during erection to ensure that trusses are maintained in a vertical plane.

Support your tank

The extra load of a water tank requires careful support. Additional trimmers across the joists support the bearers.



**DO STORE ON
SITE CAREFULLY**



**DO HANDLE WITH
CARE**



**DO FIX IT
RIGHT**



**TRUSSES DO NEED
BRACING**



DON'T CUT



**DO SUPPORT
YOUR TANK**

IF IN DOUBT - ASK!

Supporting Water Tanks

Water tank support for standard Fink Trusses

Figure 68

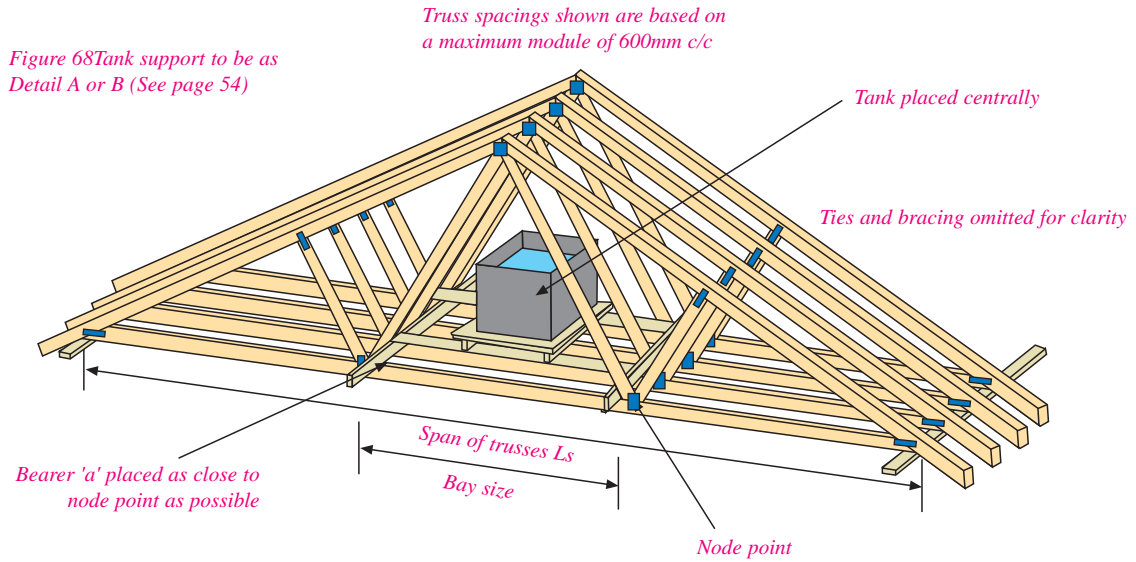
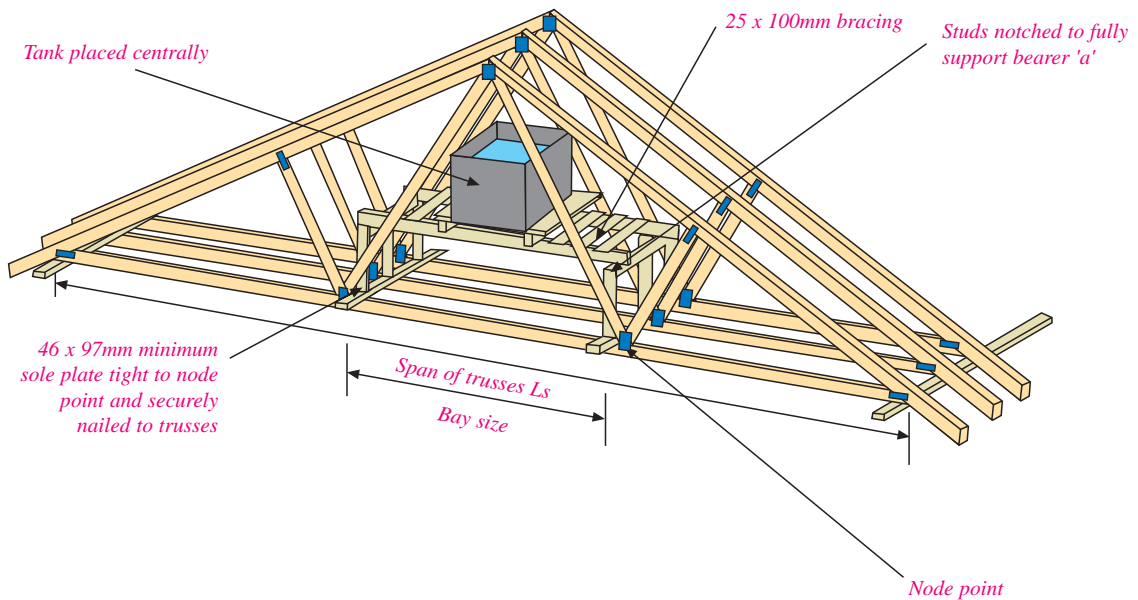

Figure 69

Water tank support platform

Tank support to be as Detail A or B (See page 54)

Note: Always carefully brace elevated tank platforms back to main truss



Supporting Water Tanks

Water tank support for Mono Pitch Trusses

Figure 70

Tank support to be as Detail
A or B (see page 54)

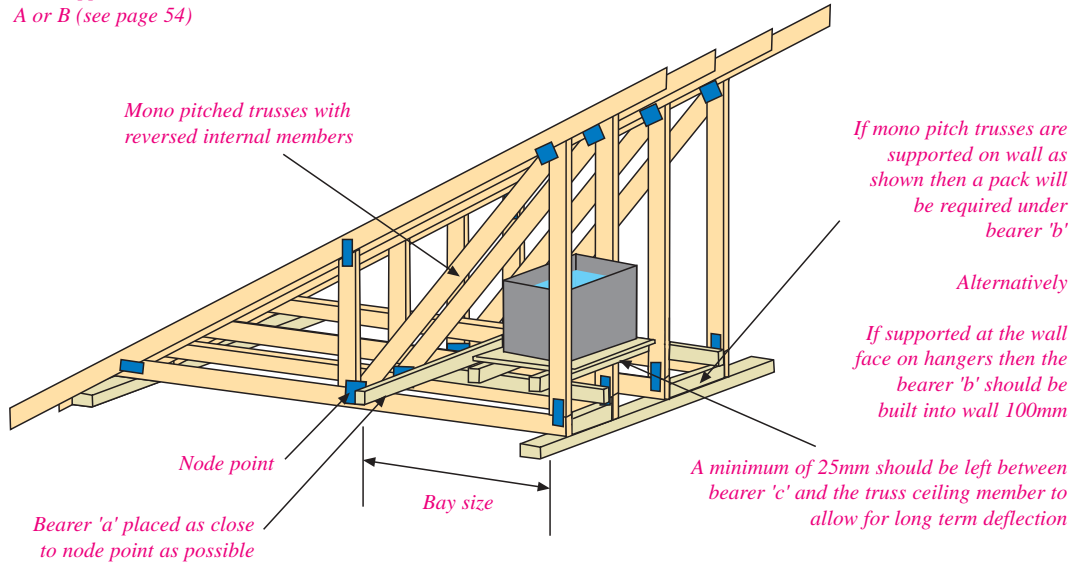

Water tank support platform for Mono Pitch Trusses

Figure 71

Tank support to be as Detail
A or B (see page 54)

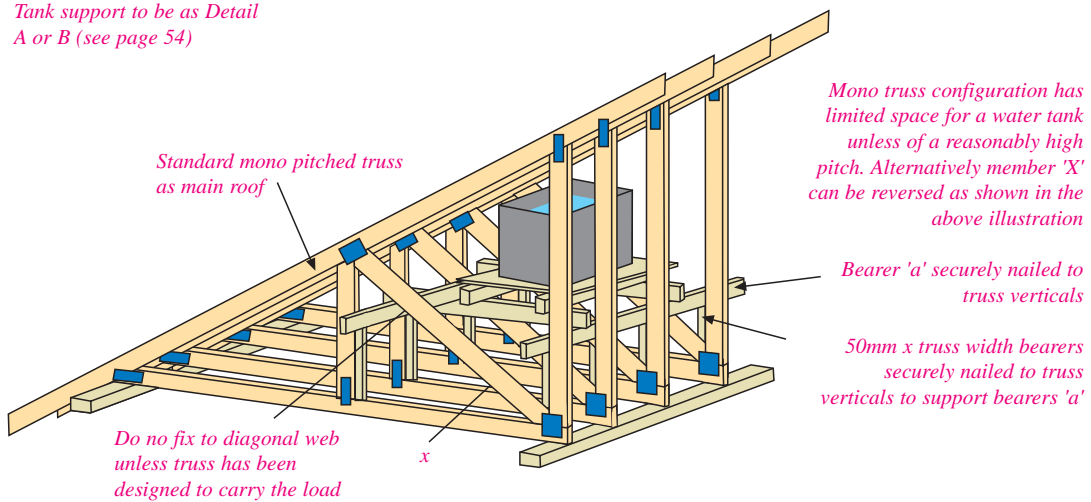

Supporting Water Tanks

Water tank support for Small Span Trusses

Figure 70

Tank support to be as Detail A or B (see page 54)

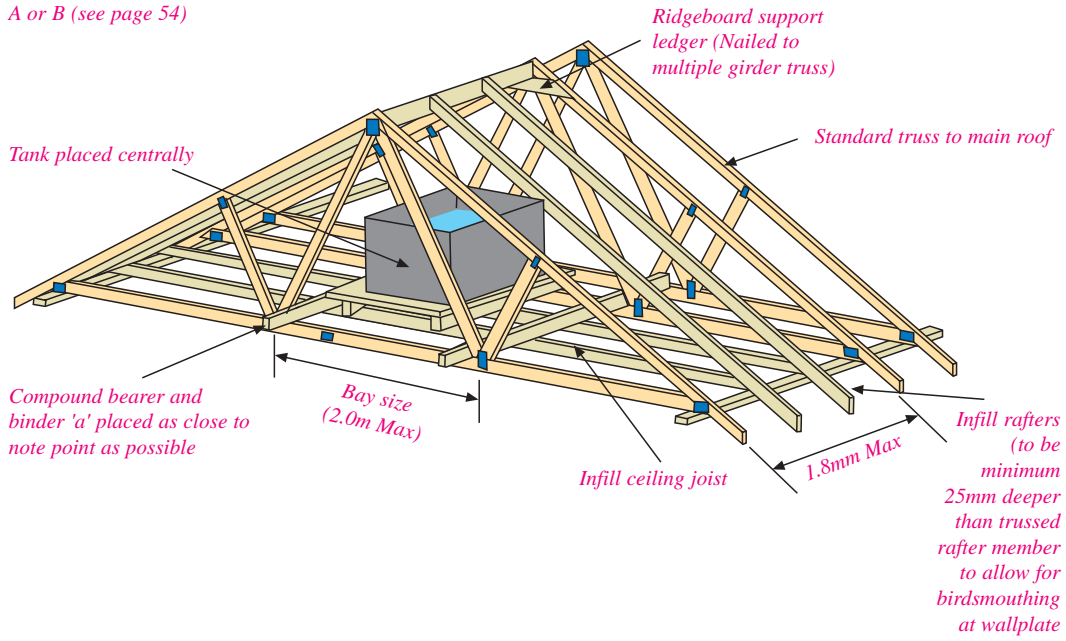
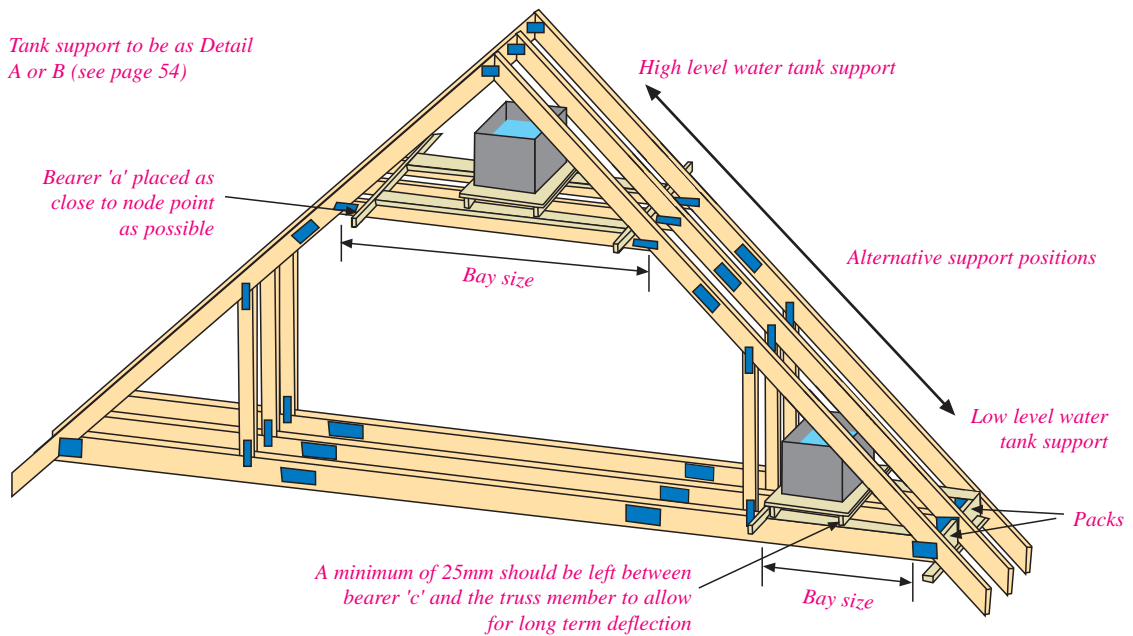

Figure 70

Water tank support for Open Plan Attic Trusses

Tank support to be as Detail A or B (see page 54)



Supporting Water Tanks

Detail 'A'

Figure 74

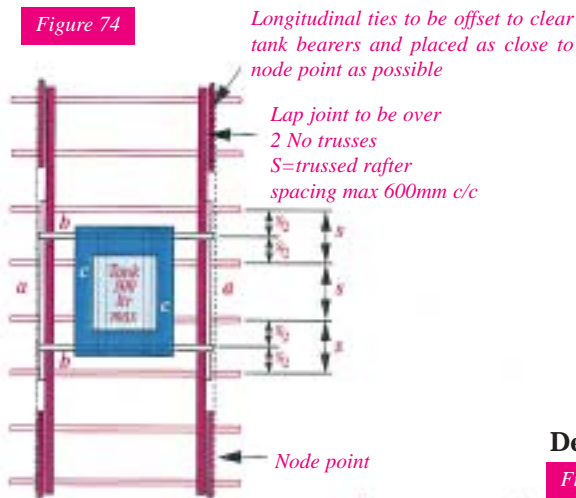

Detail 'C'

Figure 76

Longitudinal ties to be offset to clear tank bearers and placed as close to node point as possible

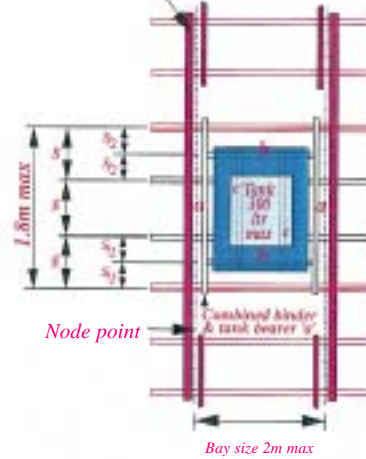

Detail 'B'

Figure 75

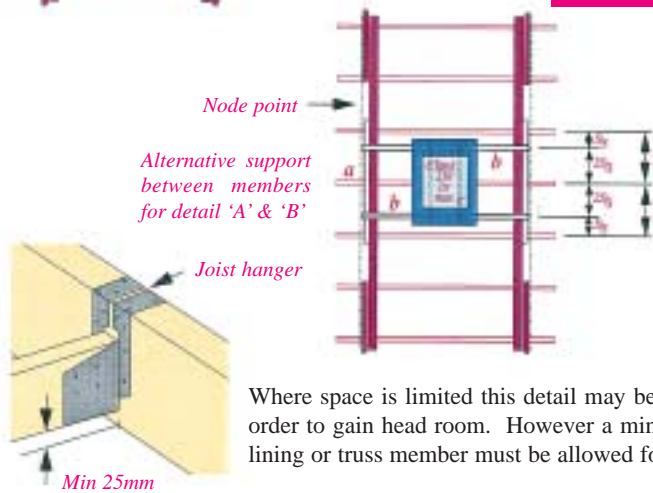

If water tanks are to be supported on the trussed rafters in accordance with the details shown then the provision for these must be taken into account at the design stage.

Otherwise, the additional loads imposed by the water tanks must be supported independent of the trussed rafters.

Where space is limited this detail may be used between members a & b and b & c in order to gain head room. However a minimum clearance of 25mm above the ceiling lining or truss member must be allowed for possible long term deflection.

Table 1: Sizes for support member

Tank capacity to marked water line	Minimum member size (mm)		Max span Ls for fink trussed rafters (m)	Max bay size for other configurations (m)
	a and c	b		
Detail 'A' not more than 300 litres on 4 trussed rafters	47 x 72	2/35 x 97 or 1/47 x 120	6.50	2.20
	47 x 72	2/35 x 120 or 1/47 x 145	9.00	2.80
	47 x 72	2/35 x 145	12.00	3.80
Detail 'B' not more than 230 litres on 3 trussed rafters	47 x 72	1/47 x 97	6.50	2.20
	47 x 72	2/35 x 97 or 1/47 x 120	9.00	2.80
	47 x 72	2/35 x 120 or 1/47 x 145	12.00	3.80
Detail 'C' not more than 300 litres on 2 multiple trusses as shown	1/72 x 145 or 2/35 x 145	1/72 x 145 or 2/35 x 145	6.00	2.00

Note: Support members may be of any species with a permissible bending stress not less than that of European redwood/whitewood of C16 strength class or better.

Hatch and Chimney openings

Where possible, hatches and chimneys should be accommodated in the standard spacing between trusses.

Each member and joint in a truss performs an important role, essential to the effective functioning of all other parts and the component as a whole. Trusses must never be cut and trimmed except according to details supplied by the Trussed Rafter Designer.

The principle behind the methods and details given in this section is to ensure that no individual trussed rafter is subject to a load significantly greater than that applied, were it at standard spacing.

Figure 77a shows a system suitable for openings greater than 10% over standard and up to twice standard spacing. Battens and plasterboard should be given extra support.

Support of the loose timbers is provided in line with each truss joint by a purlin, binder or ridge board and by trimmers at the actual opening.

Figure 77a

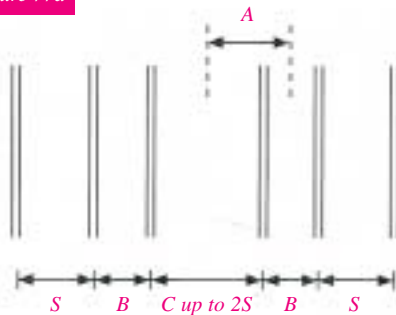

Figure 77b

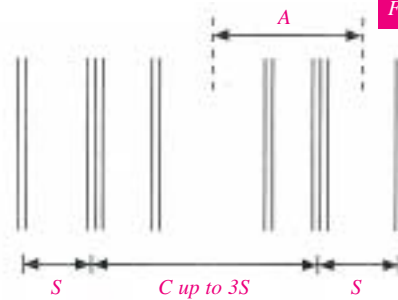
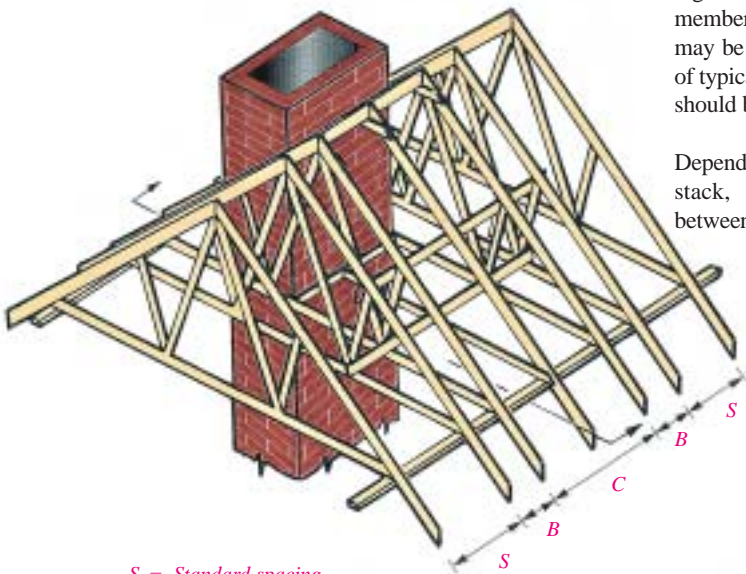

Figure 77c



S = Standard spacing
 C = Chimney opening
 B = Reduced spacing
 A = Effective spacing

When the two trimming trusses at each side of the opening (figure 77b) are actually nominally fixed together with nails, at say 600mm centres along all members, an opening of up to three standard spacings may be used. Deeper purlins, binders and ridge board of typically 47 x 175mm and trimmers of 47 x 125mm should be installed.

Depending on the design of the chimney flue and stack, appropriate clearance should be allowed between timber and chimney.

Although intended primarily for trussed rafters, the above principles can also be used for framing with Attic Frames. Raised Tie or Extended joist trusses require careful consideration when framing around hatch or chimney openings, as often reinforcing timbers (Scabs) are already required on the 'standard' unit and it is often not possible to design multiple ply units of this type.

Figure 77b

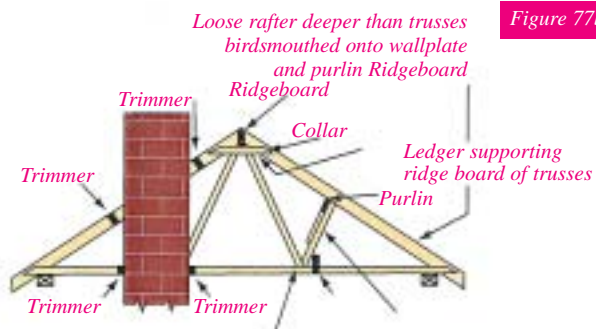

Two Tier Construction

It is necessary to use two tier trussed rafters when the vertical dimension of a single component would be too large for manufacturing or transportation. This

dimension is generally 3.9 - 4.4m but your MiTek fabricator will advise you when to expect trusses in this form.

Figure 78

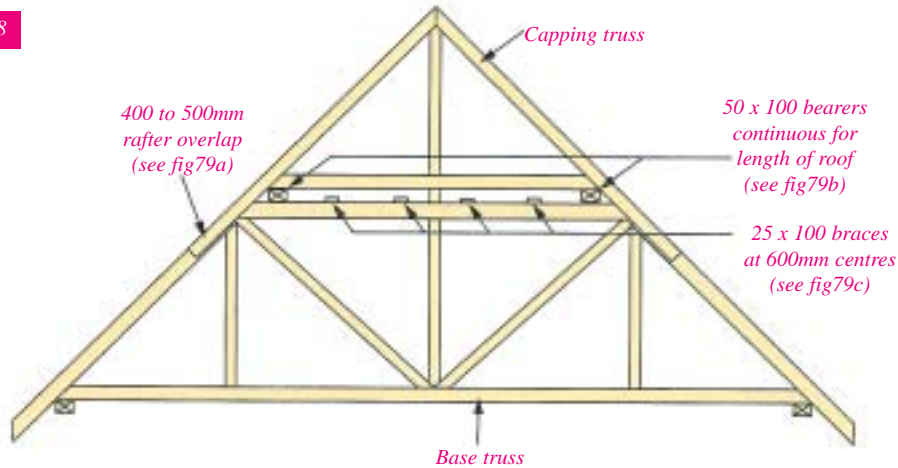

The two tier truss (figure 78) comprises a flat-topped base truss and a triangular capping truss, fitting alongside the base truss on longitudinal bearers. Each truss may be one of a large selection of types. The base truss will generally be made as high as practical but not so high that the span of the capping truss is less than 2-3m. Although a duo-pitched shape is shown in figure 78, all basic configurations can be constructed by the two tier method.

The bracing of the flat top chord of the base truss is important in ensuring its performance in compression.

The base trusses should be erected, full permanent bracing installed and battens fixed, up to the top position of the capping trusses. The resulting structure then forms a safe, rigid working platform for the erection of the capping trusses. Tiling or loading of the base trusses should not proceed until the capping trusses are fully installed and braced.

Figure 79d

Often the cap truss sits in the same plane as the base truss and they are connected together using a MiTek Field Splice plate

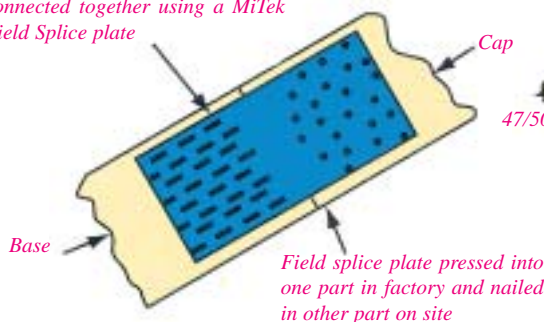

Figure 79a

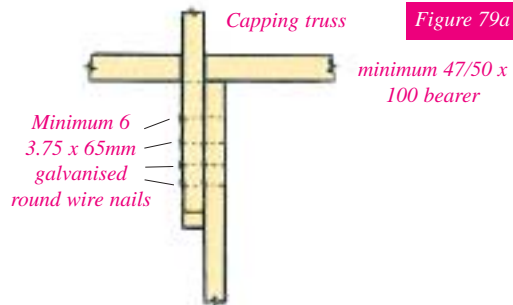

Figure 79b

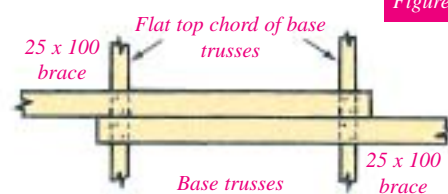
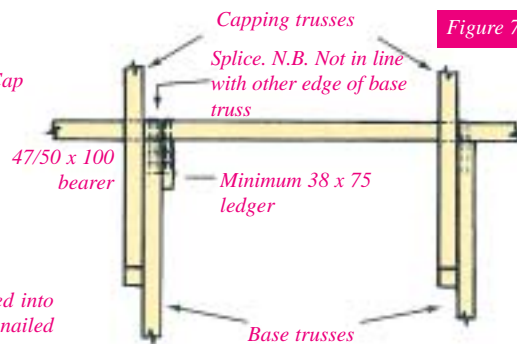

Figure 79c



Hip Ends and Corners

Typical Roof Features - Hipped Ends

The most common end shapes are the Gable End, which allows the simplest roof framing and uses most support wall surface; the Hipped End which offers a simple wall solution at the expense of a more

complex roof structure, and the Dutch Hip and Gable Hip, which are compromises between a gable and hip, easily formed using trussed rafters.

Figure 36a

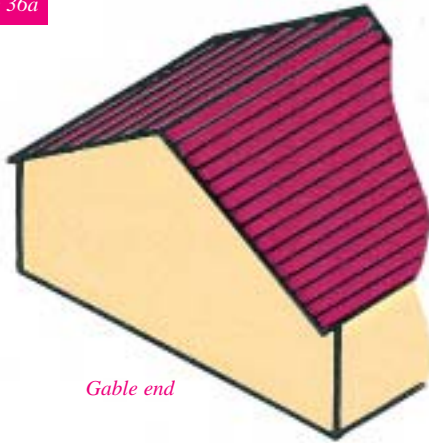

Gable end

Figure 36b

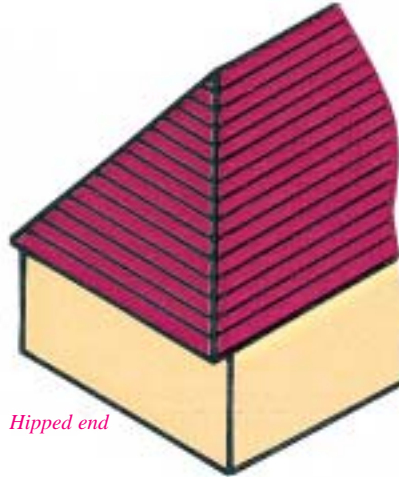

Hipped end

Figure 36c

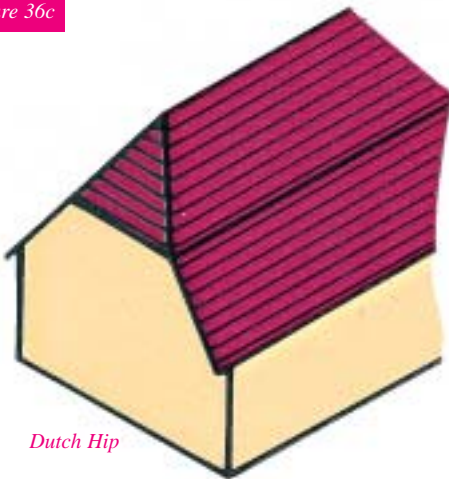

Dutch Hip

Figure 36d

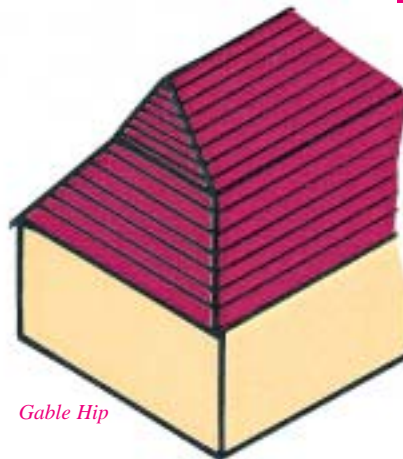

Gable Hip

Figure 37a



Action of hip end

Figure 37b



Traditional hipped end

Most traditional hipped ends behave like an inverted conical basket and, under load, the tendency for its rim (the wall plate) to spread is resisted by friction (lateral force on the wall), tension in the rim (tension and bending in the wall plate) and tension in the weft (the tiling battens). In the long term the results are sagging hip boards and rafters, bulging walls and characteristic horizontal cracks in the masonry at the inside corners of the dwellings roughly 300-600mm below ceiling level.

However, hipped end systems develop by MiTek do not depend on tension in battens, or a massive wallplate and horizontal resistance from the walls. With suitable bracing, the trussed rafter hip roof provides the walls with the stability required by Building Regulations.

Hip Ends and Corners

Hipped Ends

The simplest form of hipped end consists of a multi-ply girder of standard trusses securely nailed or bolted together, which support loose rafters and ceiling joists, as in figure 38.

This is the most inexpensive form of hip because no special trusses are needed other than the girder, but their use is limited to spans up to 5m.

Loose rafter and ceiling joist sizes should be taken from Approved Document A to the Building Regulations. Hip boards should be supported off the girder by means of a ledger. The ceiling joists should be supported by proprietary joist hangers.

Figure 38

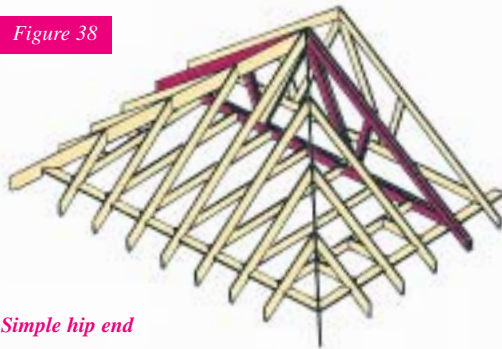

LEDGER DETAILS

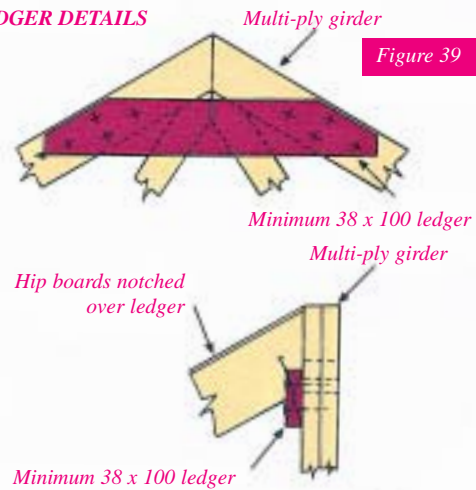
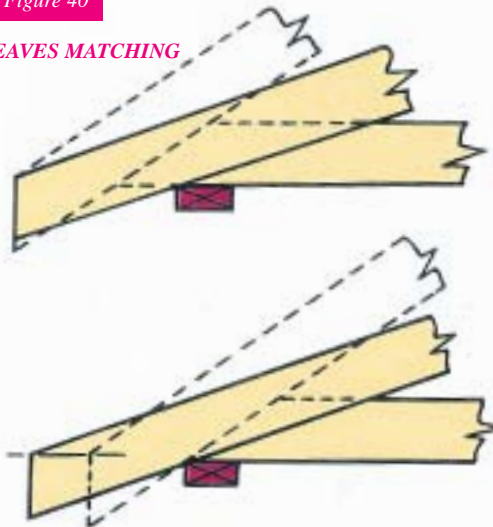

Figure 40

EAVES MATCHING



If the end pitch is different to the pitch of the main roof, the eaves details should be discussed with your trussed rafter supplier. It is advisable to ensure that the top extremities of rafter overhangs are at the same level to provide for continuous guttering. Note that whilst adjustments can be dealt with on site in loose timber construction, the mono-pitched trusses used in other hip types must be made correctly in the factory.

It should also be noted that all forms of hip construction employing a hip board exerts a horizontal thrust at the wallplate corner junction. Having taken up any horizontal movement, of course, the structure becomes stable. Movement of the wallplate can be controlled by fixing a 1200mm length of galvanised steel restraint strap around the outside. See figure 41.

Figure 41

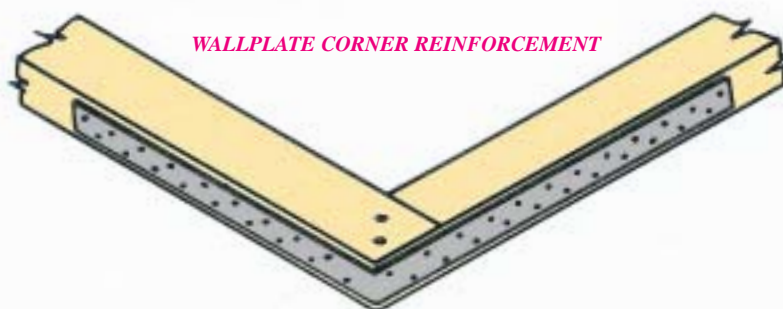

MiTek trussed rafter suppliers can provide detailed advice on hipped end roof details.

Hip Ends and Corners

Hipped Ends - 'Stepdown'

The step-down hip system uses flat top hip trusses of progressively diminishing height from the ridge to the girder truss position. This system is rarely used as each truss is different to make. The number of step-down hip trusses is determined by the need to maintain reasonable sizes for the loose ceiling joists and hip board in the hipped corner infill areas. For these reasons, the span of mono-pitch trusses is not usually greater than 3 metres in the case of regular hips, where the hip end pitch is the same as the pitch of the main roof.

hip truss to support tiling battens. The web configuration of the various truss types shown (including the mono-pitch) are typical, but will be chosen to provide the best structural solution. Fortunately, this system is flexible in accommodating large spans and irregular hips with unequal roof pitches and employs standard, designed truss types throughout.

Noggings must be fitted between the flat chords of the step-down

Figure 42

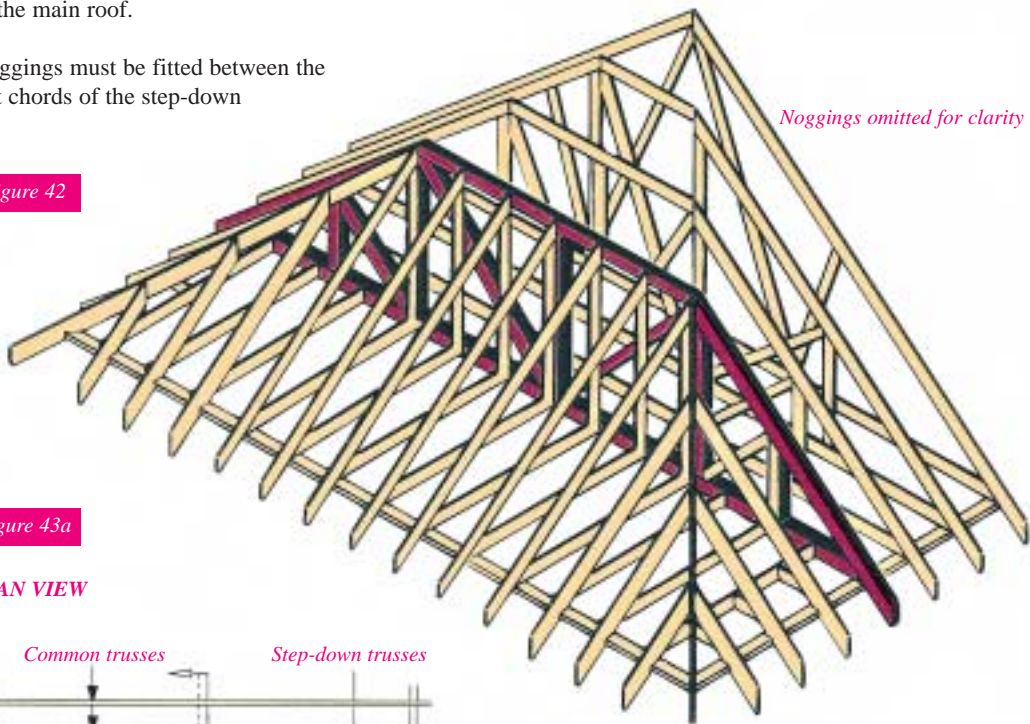

Figure 43a

PLAN VIEW

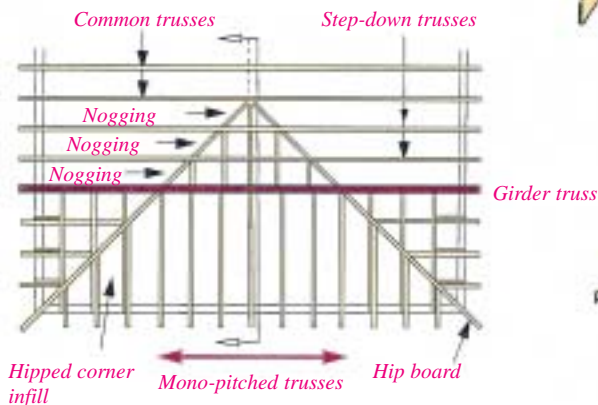

Figure 43b

SECTION

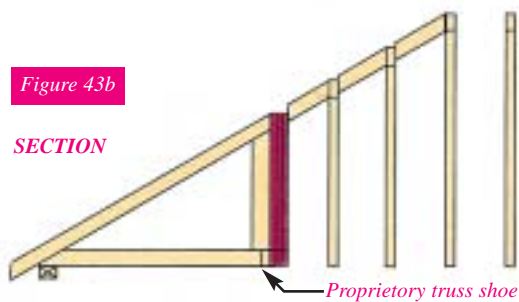
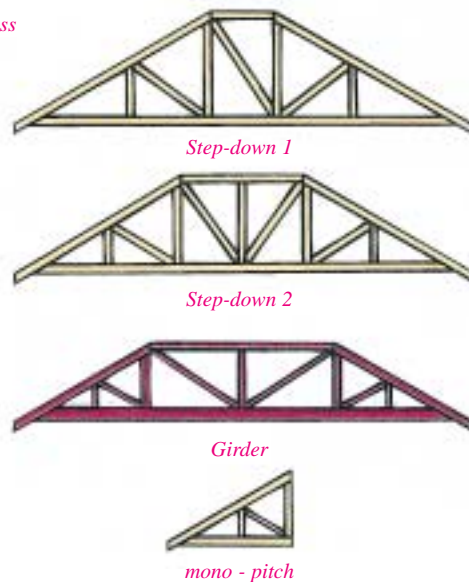

Figure 43c

TRUSS COMPONENTS



Hip Ends and Corners

Hipped Ends - 'Flying Rafter'

Of the many types of hip systems this one has an obvious manufacturing advantage: There is only one basic hip truss profile. All the hip trusses, including those forming the girder truss are identical; and the mono-pitch trusses supported off the girder have the same profile as the sloped part of the hip trusses, which speeds up fabrication and reduces the overall cost of the hip system.

The rafters of the mono-pitched trusses and/or hip trusses are extended and are site cut to fit against the upper hip board. Off-cuts may be required to be nailed in position to the rafters of the hip trusses. For the longer rafters props may be required to run down to the trusses underneath.

The flat parts of the top chords of the hip trusses and girder must be securely braced together to ensure stability.

The hip corner may be constructed from pre-fabricated rafter/joist components commonly called Open Jacks or all the corner can be framed with loose rafters, joists and hipboards on site. The hip board is notched over the girder truss and supported off ledgers at the apex of the hip.

This system offers the advantage of continuous rafters and thus easily constructed smooth roof slopes.

Typical spans using this construction with one primary multi-ply hip girder would be 9.6 metres.

Larger spans, up to 13.2 metres, may be accommodated by the use of intermediate girders between the main girder carrying the mono-pitch trusses and the hip apex.

It is possible to construct several types of hip end using the *'Flying Rafter'* concept, or indeed, to combine the *'Step-down'* concept within the hip trusses with the *'Flying Rafters'* on the hip end mono-pitch trusses.

Please contact your truss supplier if you have a preference for a particular method of construction, as the MiTek design system can encompass any method.

- 1 Flat top chords require bracing
- 2 Ledger under to support hip boards
- 3 'Flying Rafters' on hip trusses (may require props to trusses below)
- 4 Girder
- 5 Infill rafters
- 6 Hipboard
- 7 Infill ceiling joists
- 8 Mono-pitch trusses

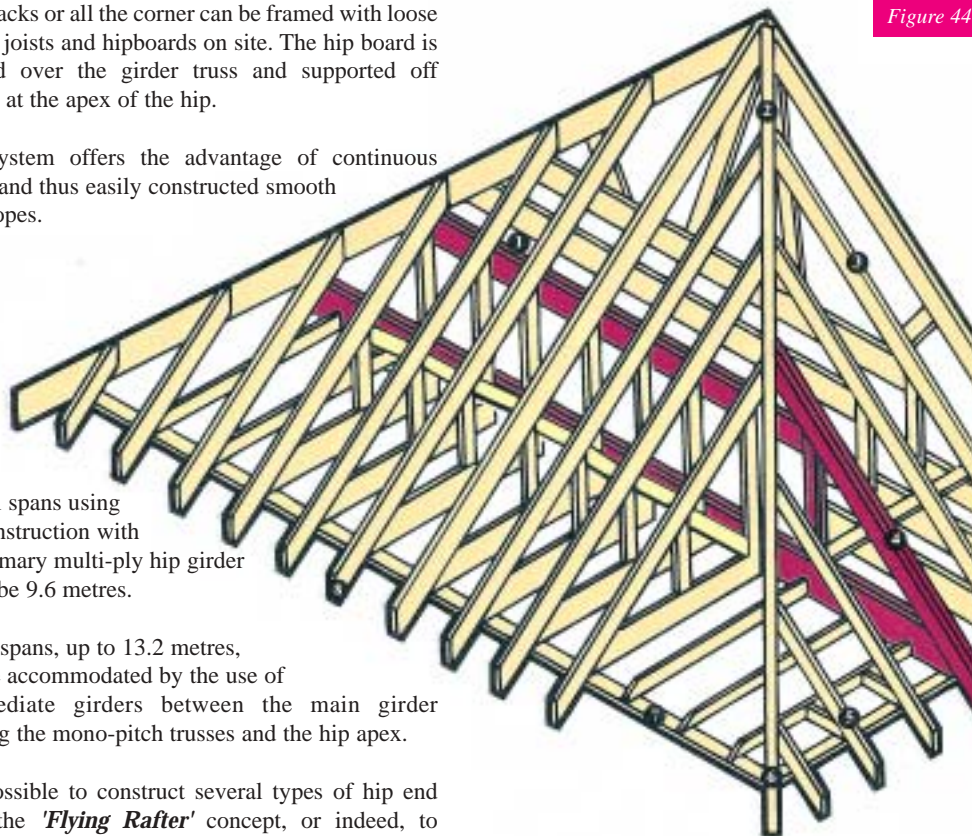

Figure 44

Rafters omitted for clarity

Hip Ends and Corners

Hipped Corners

A hipped corner is formed by the intersection, at 90 degrees, of two roofs which may, or may not be the same span or pitch.

Figure 45

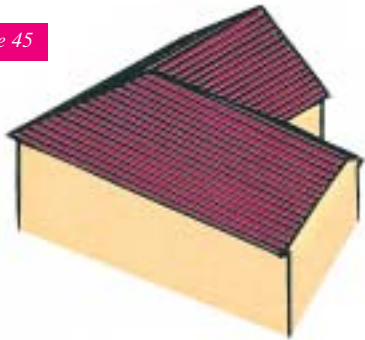

Hipped corners for mono-pitched and other roof shapes are based on the same principles described below for duo-pitched roofs.

The common framing consist of a SECONDARY half-hip girder truss supported by a PRIMARY duo-pitch girder truss. An internal load-bearing wall or beam support can often be used to perform the function of the primary girder truss.

The duo-pitch girder truss is specially designed for the exceptional loads it carries and includes a wider than normal vertical web to which a proprietary girder hanger can be fixed to carry the half-hip girder.

Figure 46a

COMPONENTS OF HIPPED CORNER

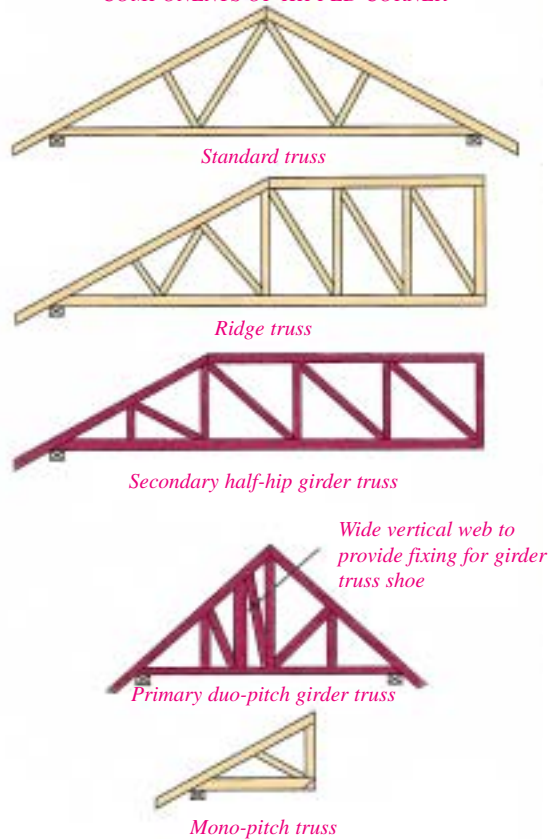
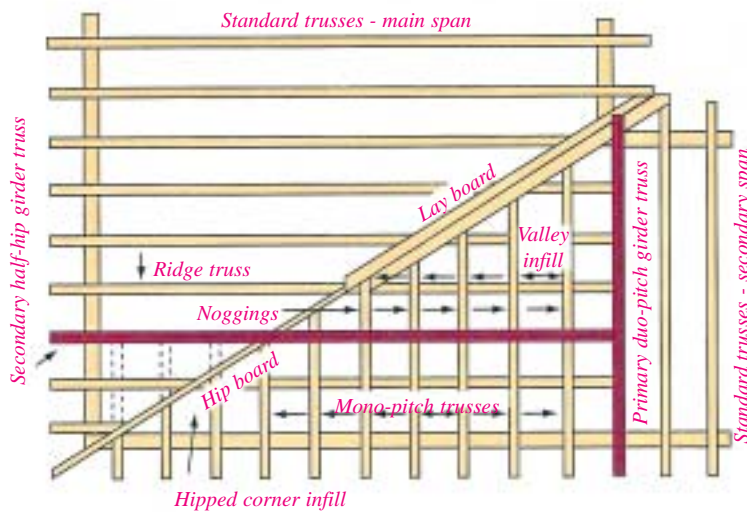

Figure 46b

PLAN VIEW



The roof is built up in the valley area using a mono-pitched valley set so that the half-hip girder carries the mono-pitch trusses and hipped corner infill, in the same way as at a hipped end. The span of the mono-pitch trusses is not generally greater than 3 metres and more than one half-hip truss may be needed between the ridge truss and the half-hip girder.

The details shown correspond to the method of construction used in the Step-down hipped end, in which noggings have to be sited between trusses to support the tiling battens.

Hipped corners with a Flying Rafter can also be provided.

Valley Intersections

'Tee' Intersections and Valley Infill

The basic junction of two roofs is known as a 'Tee' intersection, where a valley line will be formed at the point of intersection of the two sloping planes. The construction around the valley area is commonly formed by the use of either timber rafters, valleyboards and ridgeboards (not recommended) or by the use of pre-fabricated valley frames.



Figure 47a

Figure 47b



It is strongly recommended that valley frames be used in junction areas, as these provide the quickest, cheapest and most structurally effective solution to the roof framing in these areas.

The use and function of the valley frames are more important than they appear. The individual components transfer the roof loadings to the top chords of the underlying standard trusses in a uniform manner. Acting with the tiling batten between each neighbouring pair of components, they provide lateral stability to the same chords.

Some variations on the basic system are shown in figure 49. Others occur from time to time and suitable layouts can be easily devised by MiTek trussed rafter suppliers.

The layboards shown in figure 48 are in short lengths and supported off battens nailed to the sides of the rafters, to lie flush with the tops of the rafters. This enables the felt and tiling battens to be carried through into the valley. The tile manufacturers advise should be sought to ensure correct tile and pitch suitability.

In many cases, the support for the main roof trusses may be provided by a multi-ply girder truss as shown in figure 48, with the incoming trusses supported in proprietary Girder Truss Shoes at each intersection.

It is common practice on site to erect the girder truss first and position the incoming trusses afterwards.

All MiTek girders are designed to resist stresses induced in the bottom chords by the supported trusses. The connector plates on girders will typically be considerably larger than those on the standard trussed rafters.

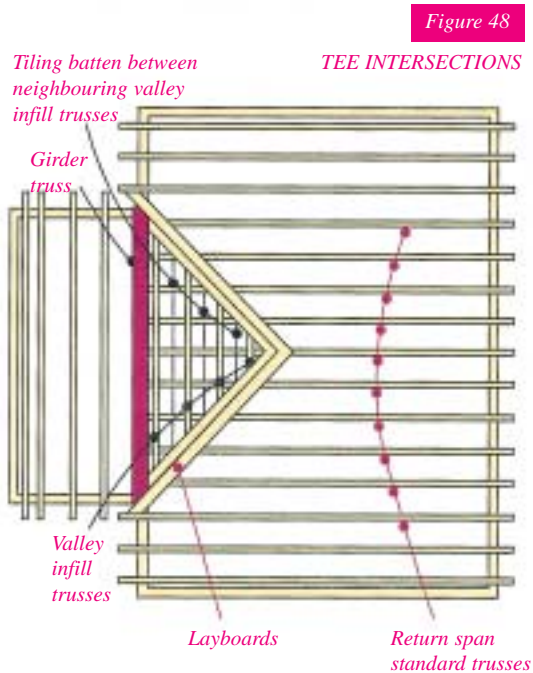

Figure 48

Figure 49



As described above, the valley construction should include intermediate tiling battens between neighbouring valley infill trusses, to provide the correct restraint for the rafters of the underlying trusses.

Figure 50



Bracing Trussed Rafters and Roofs

Bracing in trussed rafter roofs is essential and performs specific and separate functions:

1. TEMPORARY BRACING

Temporary bracing is required during erection of the trussed rafters to ensure that the trusses are erected vertically plumb, at the correct centres and in a stable condition for the continuation of construction.

This bracing is the responsibility of the roof erector, (see later for recommendations).

2. TRUSS INTEGRITY BRACING

Bracing may be required by the trussed rafter design to prevent out-of-plane buckling of a member or members within the truss. This bracing must be provided to ensure the structural integrity of the trussed rafter. It is the responsibility of the Trussed Rafter Designer to inform the building designer if this is required.

See figure 26a, 26b and 26c.

Figure 26a

TRUSS INTEGRITY BRACING
(Specified by Trussed rafter Designer)

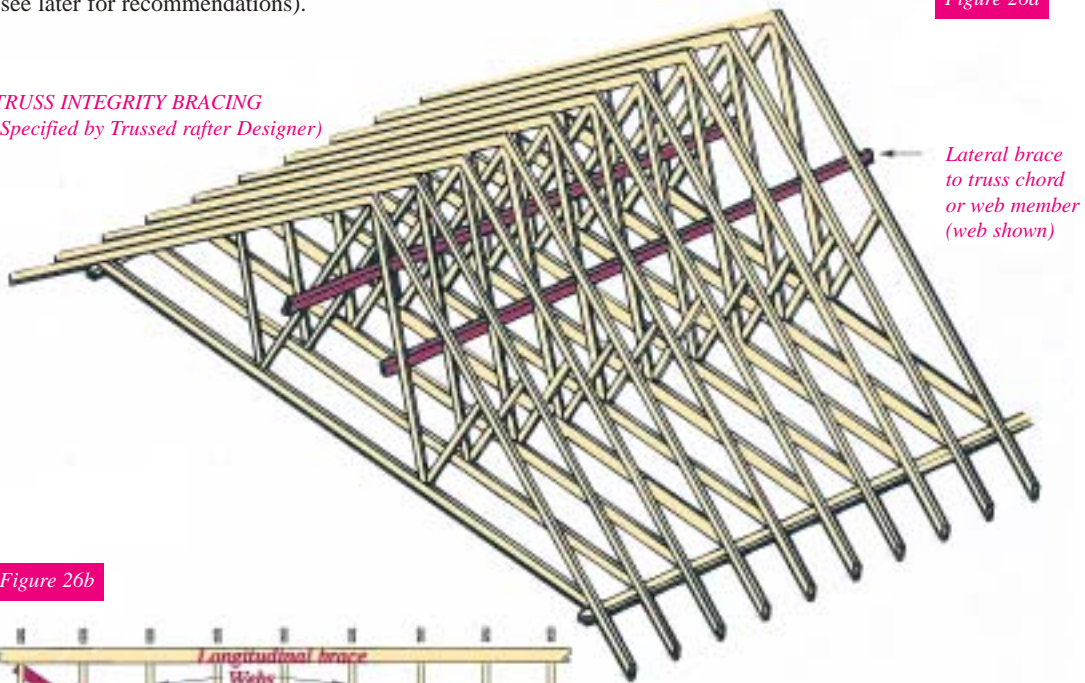
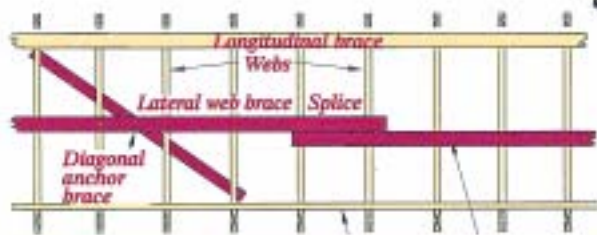

Figure 26b



LATERAL WEB BRACING

One shown (with splice) at mid point of webs. For two braces, locate at third-point of webs. Diagonal anchor braces as shown at 6m intervals. All braces 25 x 100 free of major defects and fixed with two 3.35 x 65mm galvanised nails at all cross-overs.

Figure 26c

ALTERNATIVE WEB STABILITY BRACE (use when less than three trusses in line)

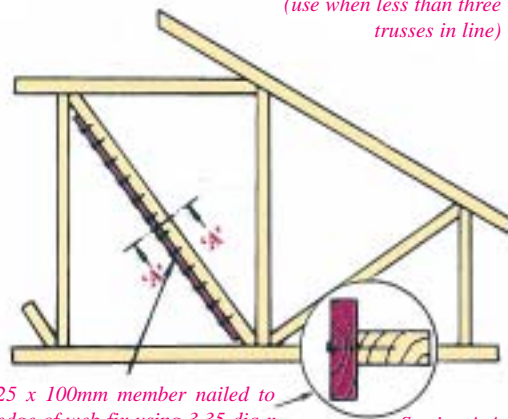

25 x 100mm member nailed to edge of web fix using 3.35 dia x 65mm long R/W galvanised nails, at 150mm centres.

3. ROOF STABILITY BRACING

In addition to the above bracing, extra bracing will often be required to withstand external and internal wind forces on the walls and roof. This area of bracing design is the responsibility of the Building Designer (or Roof Designer if one has been appointed) and includes such areas as diagonal wind bracing, chevron bracing to internal members, longitudinal bracing at truss node points, etc.

Bracing Trussed Rafters and Roofs

Figure 27a

(Specified by the building or roof designer) for guidance only please refer to BS5268-3.

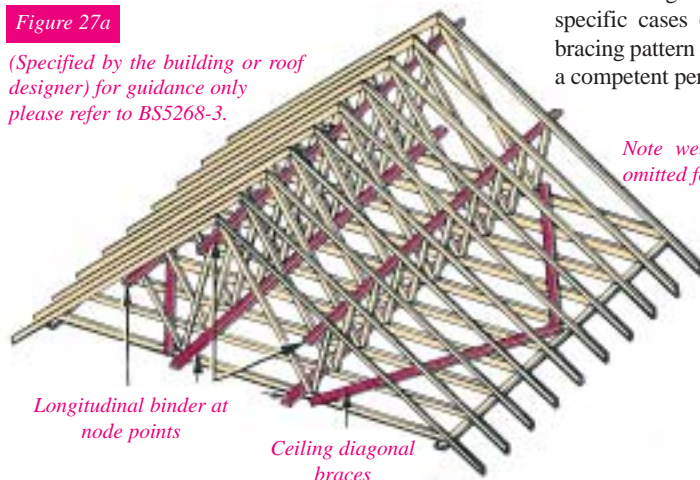

BS.5268-3 gives some recommendations for certain specific cases of roofs; for other types of roof the bracing pattern for roof stability should be designed by a competent person. See figure 27a, 27b, 27c and 27d.

Note web chevron and rafter diagonal bracing omitted for clarity, see following details.

Figure 27b



Should be inclined at approximately 45(and each nailed to at least three trusses. All 25 x 100mm free of major defects and fixed with 3.35 x 65mm galvanised nails at all cross-overs.

Figure 27c

RAFTER
DIAGONAL
BRACING

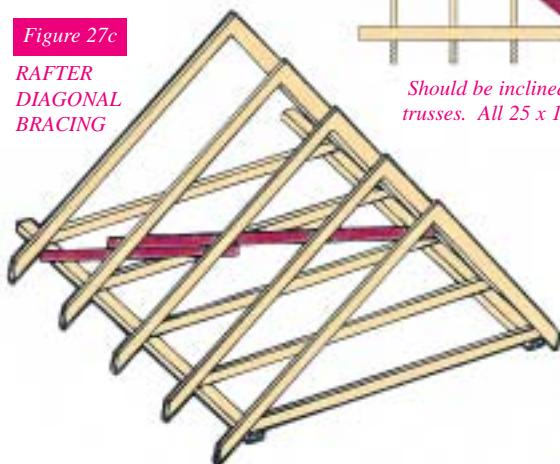

(One only shown and spliced) webs and all other bracing omitted for clarity. Braces to be 25 x 100mm free of all major defects and fixed with two 3.35 x 65mm galvanised nails at all cross-overs including wall plate. Braces to be inclined at approximately 45(to the tiling battens and repeat continuously along the roof.

Figure 27d

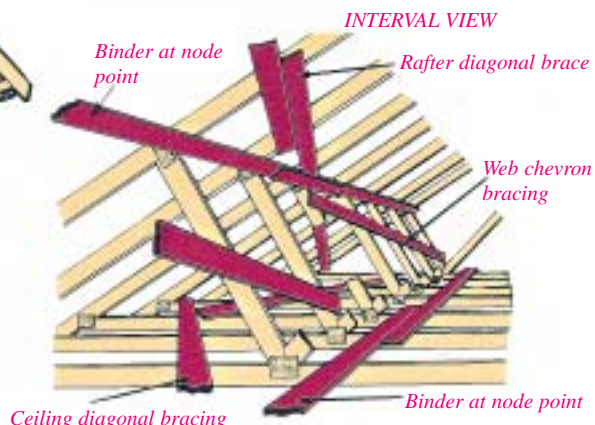

Design responsibility

Specifiers and designers should understand that Truss integrity bracing is the responsibility of the Trussed Rafter Designer who must inform the Building Designer if such bracing is required. Whereas Roof Stability bracing (and any additional specialist bracing) is the responsibility of the Building Designer (or Roof Designer if one has been appointed). The Building Designer is responsible for detailing ALL bracing.

The Building Designer has access to information pertinent to the structure i.e. walls, and the forces being transferred from them, which the Trussed Rafter Designer cannot determine. (See also section 1.2 on Design Responsibilities).

Please refer to BS 5268-3 for further guidance on bracing of roofs for domestic situations.

Loose Timber Connection Details

The use of loose infill members and purlins is quite common on the more complex trussed rafter roofscapes. The nett result is an increased load imposed upon the trussed rafters, which has to be accommodated in the design and the requirement of a secure fixing of the loose timbers to the trusses.

It is necessary to manufacture trussed rafters either side of a loose infill area, with webs that align to ease the fixing.

It is also practical to manufacture trussed rafters with wider than normal webs to allow more tolerance for the fixing of the infill members, and is essential for the fixing of special girder hangers where larger size bolts are required.

It is important to position incoming purlins at the node points of the trusses and details 80 to 83 show practical fixing methods for variants in web arrangements at a joint.

Figure 80 For skew corner situation read in conjunction with figure 82
Use similar detail at apex for hipboard support

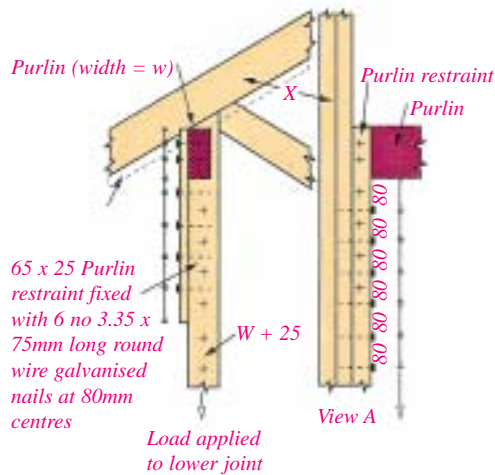

Purlin support post. Size 50 x (W + 25), extending to ceiling joist. Fix with one row of 4.0 x 100mm long round wire galvanised nails at 80mm centres for full length of post

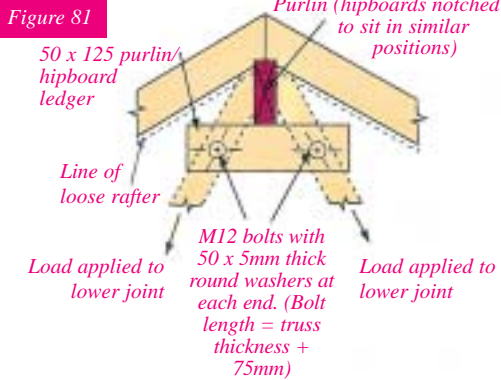

Max allowable load for this detail: 4.0Kn for C24
5.0Kn for TR26

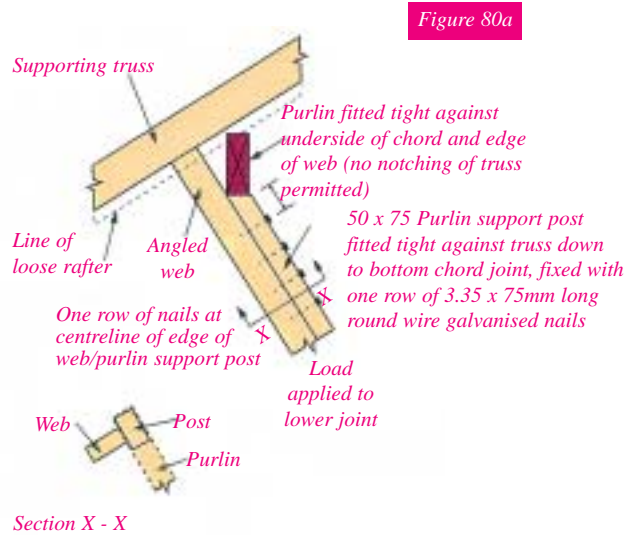
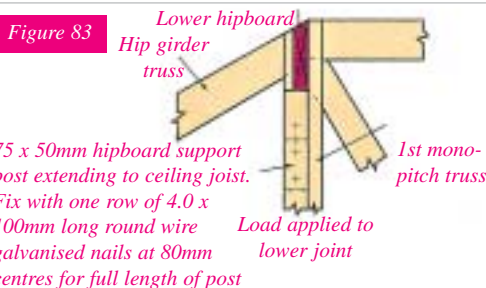

Figure 80a

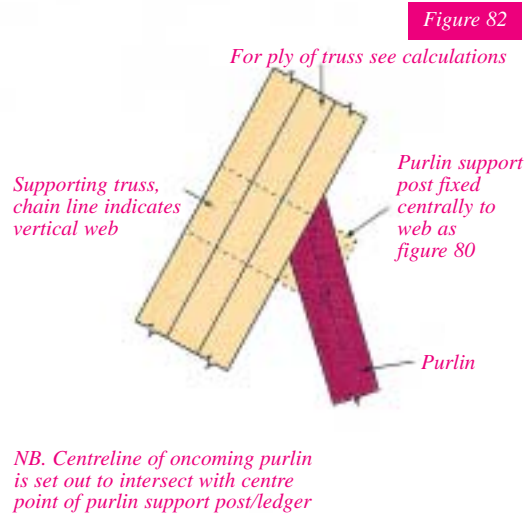

Figure 82

NB. Centreline of oncoming purlin is set out to intersect with centre point of purlin support post/ledger

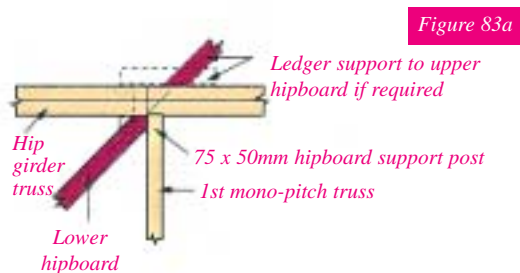

Figure 83a

NB. To support lower edge of upper hipboard use 50 x 150 hipboard ledger bolted to vertical/angled web using M12 bolts (refer to purlin, hipboard support at apex with non-vertical webs for typical fixing details See figure 81)

Bearing Details

The greatest loads to which normal trusses are subjected are the upward forces/reactions from the support through the bearings. Except for very small trusses, the line of action of these forces should be close to the centre of a joint, or a structural penalty, in the form of very large timber sizes, will be incurred owing to large bending moments.

The standard eaves detail (figure 84a) is satisfactory if the shift is not greater than 50mm, or not greater than one third of the scarf length. The 'Alternate' or 'French' heel (figure 84b) is considered in the same way but the key position is where the line of the underside of the rafter intersects the underside of the ceiling tie.

Another point to note is that as a truss ends at a vertical chord, (figure 84c) there is little scope for tolerance on length or verticality.

Where trusses are to be supported off the face of a wall (figure 84d), placing a nib at the heel of the truss is the most common solution. It is good practice to allow a nominal gap between the vertical chord of the truss and the masonry, for constructional tolerance (figure 84e and 84f). Depending on the reaction, and the grade and size of the timber in the bottom chord, a simple extension of the bottom chord may suffice (figure 84e) to form a 'nib'.

Should the bending or shear stress in the nib be excessive the whole joint can be reinforced. (figure 84f). At greater spans it is possible to use the detail in figure 84g to locate the point of intersection of the principle forces vertically over the bearing.

Figure 84a

Standard heel joint

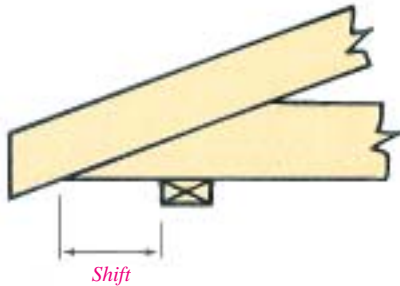

Figure 84b

French heel joint (Girder Heel)

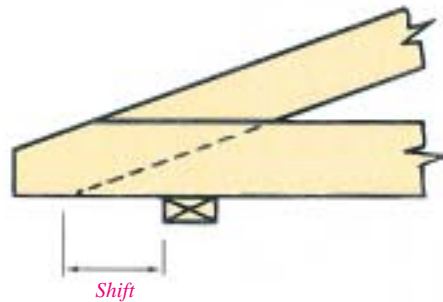

Figure 84c

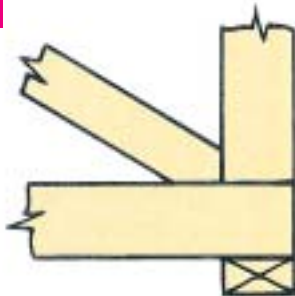

Figure 84d



Figure 84e

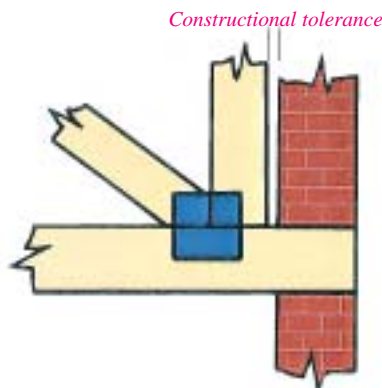
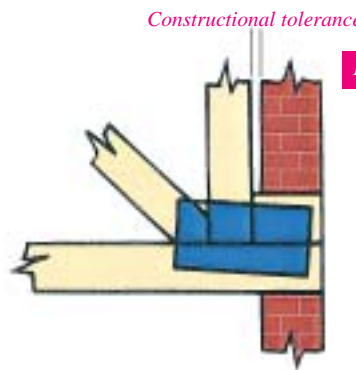

Figure 84f



Bearing Details

Consideration should also be given to protecting the timber and fasteners against dampness and aggressive ingredients in the mortar by using a dpc between truss and masonry.

the minimum height of masonry above the hanger flange and the maximum gap between the end of the trusses and the back plate of the hangers. The effect of the eccentric loading on walls loaded in this way should also be assessed.

Trusses can also be supported off the face of a wall by use of suitable hangers. The installation instructions should be noted especially concerning

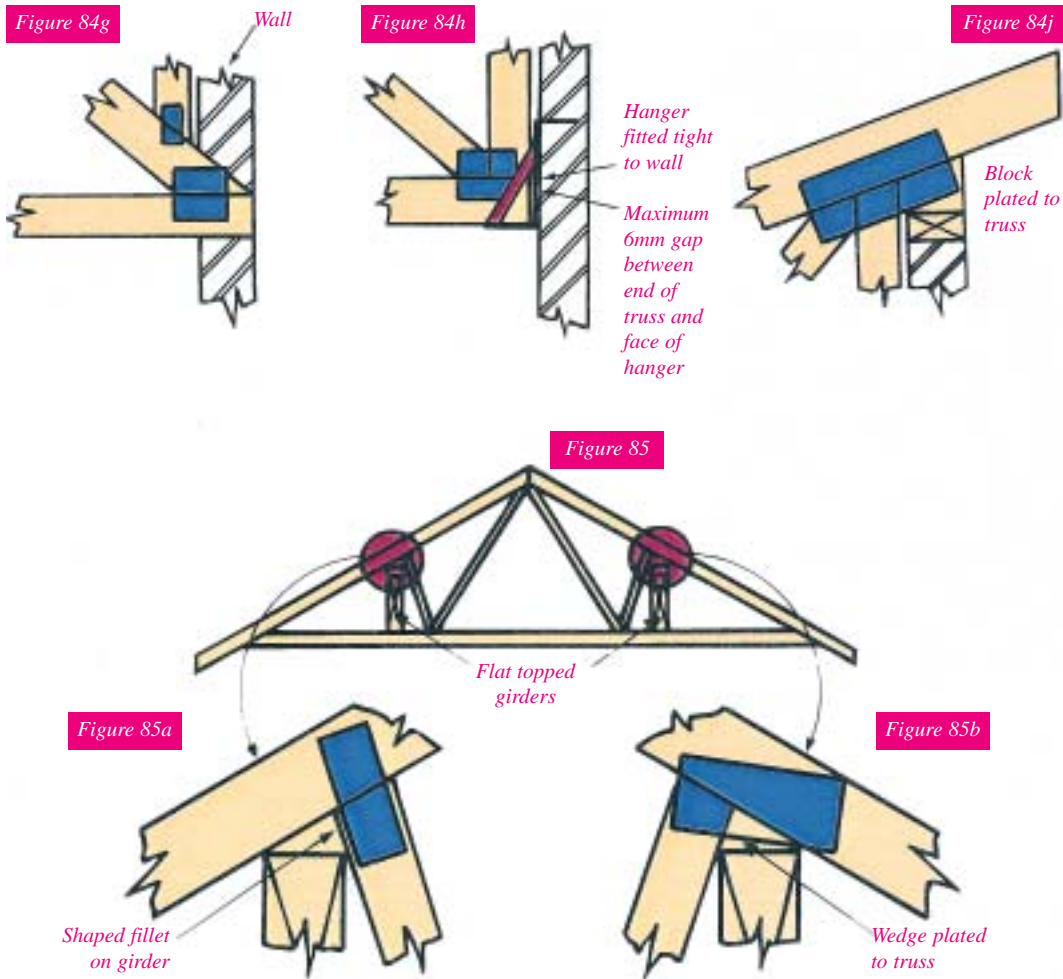

Top hung fixings (figure 84j) are not common since, at ceiling level, the wall generally needs lateral restraint from the roof against wind and the ceiling ties need to be stabilised.

Flat topped girders supporting trusses (figure 85) can be supplied with a shaped fillet (figure 85a); or trusses may have a wedge or block plated into the joint to provide a horizontal bearing surface (figure 85b).

Ventilation and Condensation

General

Roofs incorporating trussed rafters should be designed to service class 1 & 2 as defined in BS 5268: Parts 2 & 3. Guidance on the prevention of condensation in roofs is given in BS 5250.

Trussed rafters using metal fasteners should not be used where there is likely to be aggressive chemical pollution, unless special precautions are taken to ensure durability of the roof timbers and fasteners. Consideration should also be given to the possibility of the corrosion of fasteners in contact with some type of insulation materials.

Reasonable access to the roof space should be provided to allow periodic inspection of the timber and fasteners.

Thermal Insulation

In the majority of trussed rafter roofs, the insulation required to comply with the statutory regulations for thermal transmittance (U value), is provided by placing the insulating material between the ceiling tie members on top of the ceiling board. Placing insulation at this level results in a COLD ROOF SPACE.

Alternatively, the insulation may be fixed at rafter level, resulting in a WARM ROOF SPACE. A warm roof space is normally constructed where habitable rooms are to be provided within the roof, as in Attic or Room in the Roof construction.

Ventilation

It is essential that cold roof spaces are effectively ventilated to the outside to prevent condensation, which may form in the roof void.

In addition, to minimise ingress of water vapour into the roof space from rooms below, all joists and service entry holes in the ceiling construction should be sealed effectively.

The location and size of ventilation openings should be determined by the Building Designer, taking particular account of possible blockage by insulating materials, sound transmission, spread of fire and entry of birds, driving rain or snow. Openings should be located near ceiling level in the eaves or external walls enclosing the roof space, or both, and should be equally distributed between at least two opposite sides of the roof. Additional ventilators may also be placed in the ridge.

The size and number of openings may be calculated, taking into account all the relevant factors, but disregarding any fortuitous ventilation through the roof covering, or they may be specified in accordance with the recommended minimum openings given on the following page. These are expressed as the minimum width of a continuous gap but, alternatively, a series of discrete openings of an equivalent total area may be specified, provided that the least dimension of any opening, gap or mesh is not less than 4mm.

Figure 86

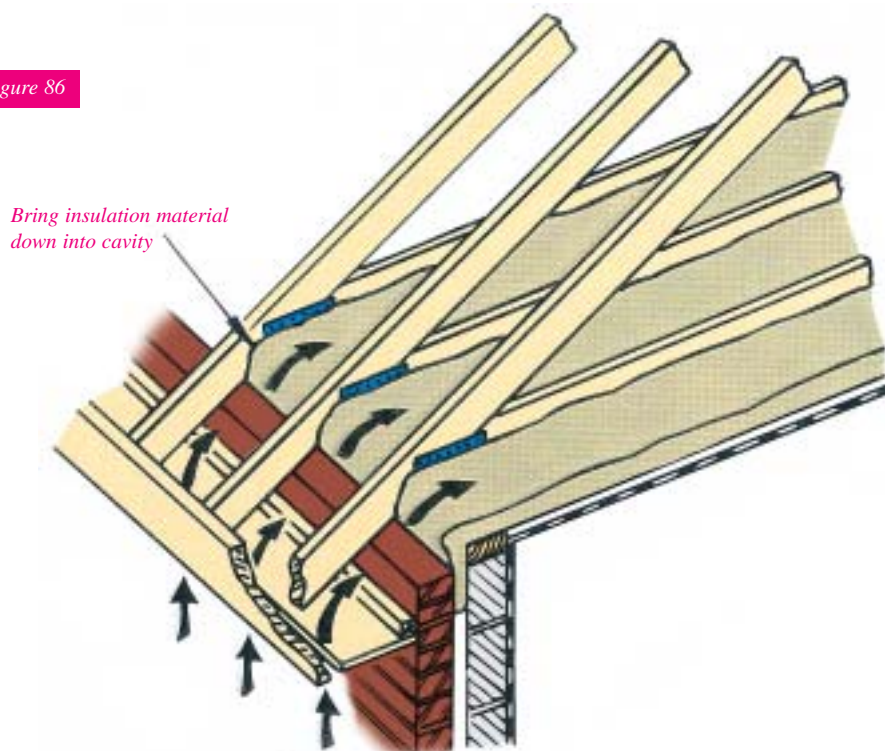

Ventilation and Condensation

The ventilation of mono-pitched roofs at ceiling level only may allow air to stagnate at the apex of the roof. To prevent this, high level or ridge ventilation, equivalent in total area to that given in the table, should be provided in addition to the ventilation at ceiling level.

Similarly, air stagnation may occur in duo-pitched roofs of more than 20 degree pitch, or 10.00m span and consideration should be given to the provision of additional high level or ridge ventilation, equivalent to a continuous gap 5mm wide.

When insulation material is close to the roof covering, as at the eaves, or where it is placed at rafter level to form a warm roof space, (as in attic and raised tie construction),

Minimum ventilation openings

Pitch of roof (degrees)	0 to 15	Above 15
Low level ventilation at ceiling level. Minimum width of continuous gap on at least two opposite sides of roof.	25	10
High level ventilation for mono-pitched roofs at or near the ridge. Minimum width of continuous gap.	5	5

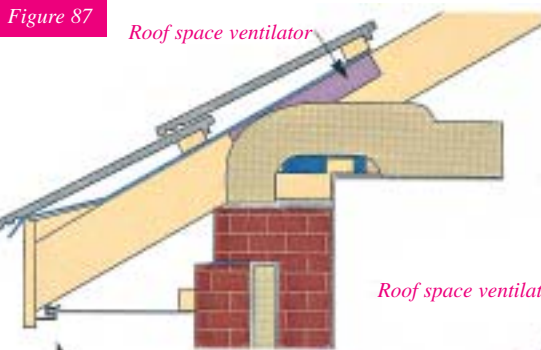

Figure 87

Roof space ventilator

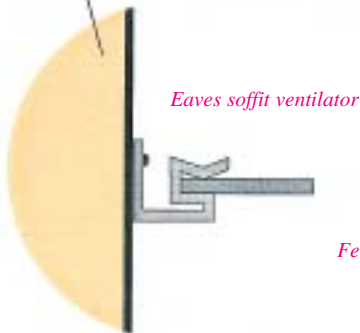

Figure 88

Eaves soffit ventilator

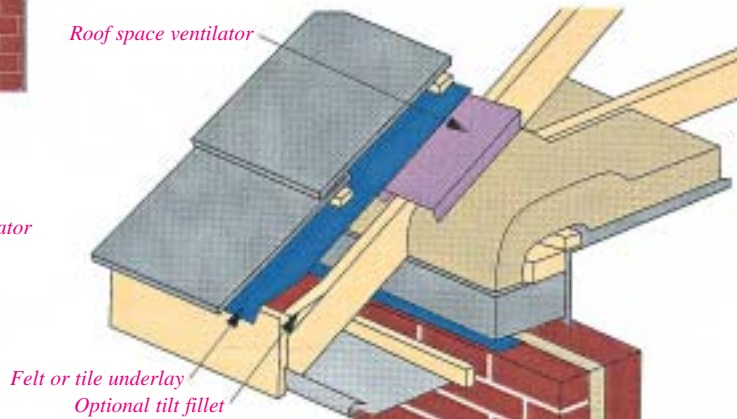

Figure 89

Roof space ventilator

Felt or tile underlay
Optional tilt fillet

it is essential to provide an air gap or not less than 50mm between the top of the insulation and the underside of the roof covering or sarking. This gap, which should allow uninterrupted air circulation immediately above the insulation, should be ventilated to the outside at the eaves and, when insulation is placed at the rafter level, also at the ridge. The minimum opening at the eaves to provide

adequate ventilation of the air gap above the insulation in a warm roof space should not be less than that shown in the table for low level ventilation and the ridge ventilation should be not less than that provided by a continuous gap 5mm wide. In normal circumstances, further ventilation of warm roof spaces is not required.

Site Storage and Handling

Introduction

(General Information relating to Health and Safety issues in Trussed Rafter Construction).

When the Construction (Design and Management) Regulations were published in 1994, a fundamental change in approach was initiated with regard to the attitude toward and significance of issues relating to Health and Safety in the Construction Industry. Since that time, a raft of further supporting legislation has been drafted and published which together now document in great detail the duties, obligations and responsibilities of those engaged in the process of Construction, from members of the original design team to trainee operatives working on site.

In order to fully understand and implement the requirements of these Regulations it is necessary to appreciate and recognise these new philosophies by making the necessary changes in working practices to elevate the profile of Health and Safety issues across the full spectrum of Construction Activities. This can be achieved by undertaking Risk Assessments, designing out hazards where evident, providing sufficient resources at all times, proper training and good levels of communication channels within the design team and on site.

The advice that is set out within the Sections of this handbook which provide assistance relating to issues of Health and Safety is therefore illustrative only and does not form prescriptive advice on any of the matters discussed. It is vital that each project should be approached by the parties involved as a fresh challenge from the point of view of Health and Safety to allow creative and innovative solutions to be developed. Readers of this handbook are therefore encouraged to fully acquaint themselves with the various Regulations, and particular:-

Health and Safety at Work Act 1974
Construction (Design and Management) Regulations 1994
Management of Health and Safety at work Regulations 1992
Provision and Use of Work Equipment Regulations 1992

Construction (Health, Safety and Welfare) Regulations 1996 - (CHSW Regulations 1996)
Manual Handling Operations 1992
Workplace (Health, Safety and Welfare) Regulations 1992

Unloading Trussed Rafters

(Information for the safe unloading of trussed rafters).

When the delivery of trussed rafters arrives on site the contractor(s) involved should be prepared and already allocated sufficient and suitable resources to ensure that trussed rafters are unloaded safely and in a manner so as not to overstress or damage the trusses. This operation will have been subject to a Contractors General Risk Assessment and then detailed in a safe working method statement that has been approved by the principal contractor or the person responsible for Health and Safety on site. Normally trussed rafters will be delivered in tight bundles using steel or plastic bindings. This will often require mechanical handling equipment, such as a forklift or crane, to enable the safe manoeuvring of these large units. The safe working method statement should accommodate any special handling instructions or hazards specified by the designer in his risk assessment for the truss design.

Site Storage of Trussed Rafters

(Methods for the proper and safe storage of trussed rafters on site).

Trussed Rafters can be safely stored vertically or horizontally at ground level or on any other properly designed temporary storage platform above ground level. Whichever method and location is chosen the temporary support should be set out to ensure that the units do not make direct contact with the ground or any vegetation and be so arranged as to prevent any distortion. The delivery of trussed rafters should wherever possible be organised to minimise site storage time, however where longer periods of storage are anticipated then the trusses should be protected with covers fixed in such a way as to allow proper ventilation around the trusses.

When stored vertically, bearers should be positioned at the locations where support has been assumed to be provided in the design with stacking carried out against a firm and safe support or by using suitable props.

SAFE VERTICAL STORAGE

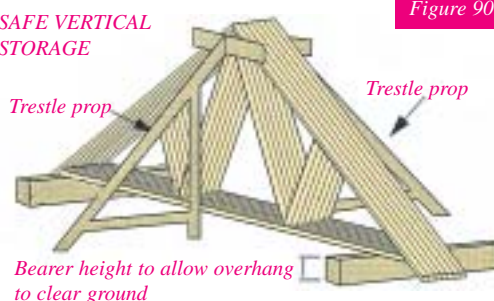

Figure 90

Site Storage and Handling

When trusses are stored horizontally, level bearers should be positioned beneath each truss node (minimum) to prevent any deformation and distortion. (See figure 91 below).

Figure 91

SAFE HORIZONTAL STORAGE

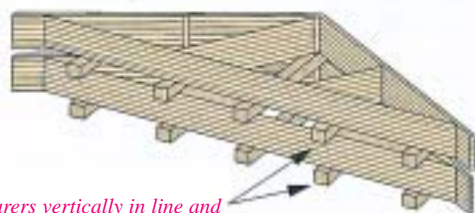

Bearers vertically in line and at close centres

No other method of storing trussed rafters is considered to be suitable, except where specific provision has been made in the design for an alternative temporary support load case.

At such time when it is necessary to remove the pre-tensioned bindings from a bundle of trusses, extreme care should be exercised. As a precaution against destabilisation of the whole bundle of trusses, it is recommended that prior to the removal of the bands, timber battens are fixed across the bundle at several locations with a part driven nail into every truss. Such a simple precaution will allow the safe removal of single trusses once the steel bands are removed. A suggested arrangement of batten locations for a standard Fink truss is shown in figure 92 below.

Figure 92

DIAGRAM ILLUSTRATING SAFE METHOD OF BREAKING A BUNDLE OF TRUSSES

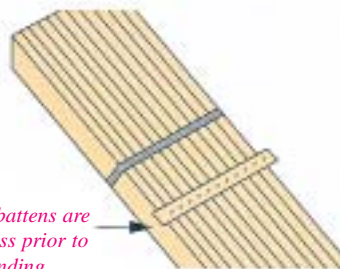

Ensure that the battens are fixed to each truss prior to release of the binding

Alternative details relating to this procedure and which involve the unbundling of the trusses whilst on the back of the lorry should be communicated by the contractor to the truss manufacturer prior to their delivery to site.

Manual Handling of Trussed Rafters

(Information relating to manoeuvring trussed rafters around the site using manual handling techniques).

With careful consideration manual handling methods

can be safely employed to move trussed rafters around a construction site, although the choice of method will depend to a large extent on the particular circumstances of the lifting operation. Such operation will generally be identified in a contractor's safe working method statement that takes account of all the assessed risks and which utilises and refers only to the resources which are available to the site. The preparation of this method statement should be undertaken sufficiently in advance to ensure the adequate planning and co-ordination of the task and sourcing of any special equipment that may be required. For example, a situation where the manual handling of trussed rafters may be appropriate might be the lifting of single trusses on to residential units not exceeding two storeys in height.

Whatever technique is adopted to manually manoeuvre trussed rafters it is vital that the technique takes full account of any special instructions issued by the designer to ensure that the structural integrity of the units is maintained and that there is no risk of damage to the trusses.

Mechanical Handling of Trussed Rafters

(Information relating to manoeuvring trussed rafters around the site using mechanical handling techniques).

Where it is not possible for reasons of safety or other practical considerations to implement manual handling techniques to manoeuvre trussed rafters, other means that involve the use of mechanical handling or lifting equipment will be necessary. Using such equipment gives the option of being able to move larger and heavier loads and consequently, the ability to raise completely or partially assembled sections of roof that have been pre-assembled at another location (for example, on the ground level superstructure of an adjacent plot). Similar considerations to those identified in the section relating to manual handling remain relevant, although as the size of the loads increase, issues of instability and potential distress/damage to the trussed rafters becomes more critical. For this reason, it is vital that trusses or sections of roof are only lifted at locations approved by the truss designer, such locations being preferably marked on the units at the time of their manufacture. Where appropriate, the use of spreader bars and strongbacks may be required to ensure an even distribution of lifting points.

Site Storage and Handling

An example of the use of a spreader bar is shown in figure 93 below.

Figure 93

MECHANICAL HANDLING

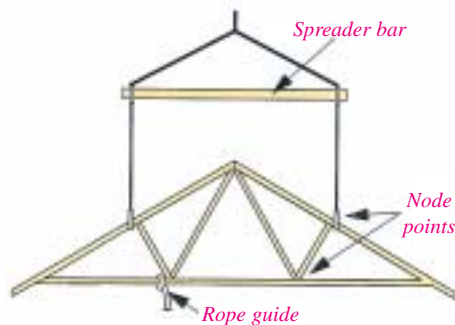

Where bundles of trusses are raised to roof level, caution should be exercised in the removal of the restraining bands (see section 3.11 figure 92). Should these bundles of trusses be stored either on a temporary working platform or at eaves level, the contractor should take the necessary steps to ensure that the supporting structure has sufficient strength and that a storage system as illustrated in either figure 90 or 91 is constructed.

Designated slewing areas should be cordoned off and the movement of operatives either restricted or prohibited within this area during all lifting operations.

At all times, strict adherence with the Contractors method statement should be observed.

Where circumstances and design considerations dictate that pre-assembled sections of roof, such as hips etc., (or indeed, complete roofs) are raised in one single lifting operation, particular attention should be given to the method of lifting the assembled sections. Such large and unwieldy loads require that checks should at least be made regarding the following:-

- Prevailing weather conditions, with particular reference to wind speed.
- A survey of obstacles in the slewing area, including scaffolds, towers and overhead services.
- A survey of the accuracy of construction and setting out of the pre-assembled roof structure.
- Underground services locations to avoid damage by the use of large cranes etc.

These sorts of techniques have the potential to save significant amounts of time and money on site whilst additionally offering significant Health and Safety benefits to all employees and personnel, although they generally require early design input and planning to ensure sufficient strength is inherent during the lifting procedure. Typical benefits which may be associated with improvements in matters relating to Health and Safety include:-

The immediate provision of stable sections of roof, away from which infill sections of roof can be constructed, rather than relying on temporary bracing.

- All assembly operations are carried out at ground level and therefore the risk of operatives falling is totally eliminated.
- The risk of operatives being struck by falling objects during an alternative roof level assembly is significantly reduced.

Clearly, there are many other benefits relating to speed, efficiency and the overall costs associated with the construction process.

Mechanical handling and lifting operations are essential where the scope of the works falls outside of simple residential scale projects.

Erection Procedure

Assembly of trussed rafter roofs

(Information relating to the assembly of trussed rafter components and infill)

Once the trussed rafters have been safely raised to eaves level utilising either the methods or principles outlined previously and assuming that all the necessary information has been forwarded by the Roof Designer to the contractor, then it is possible for the assembly of the trussed rafter roof construction to commence. In similar fashion to the other work tasks associated with trussed rafter roof construction, the assembly of the roof components should be carried out in strict accordance with a contractor prepared safe working method statement (*see section 3.13 for a typical example of a Contractors General Risk Assessment and supporting Method Statement*).

Whichever method of raising the trusses is utilised, the principal risks associated with assembling trussed rafter roofs in their final location are either falling, temporary instability and collapse of the partially complete structure or being struck by a falling truss/object. All of these issues need to be addressed to safely proceed with the operation. The manner in which any other residual site hazards should be dealt with should be based on the principle of a hierarchy of risk control. This principle states that the most desirable option is to design out the hazard and subsequent risk completely at the design stage and the least desirable option is to provide personal protection systems such as restraint harnesses (i.e. protection after a fall).

With regard to assembling trussed rafter roof structures, the most desirable approach for standard storey height construction (up to 3.0m from floor to ceiling) is to provide both a perimeter working platform externally and either a full or partial working platform internally and erecting the trusses using the standard erection procedure as shown in figure 94a. A useful modification to the basic bracing procedure is to rigidly brace the first truss back to the external scaffold to allow roof assembly to proceed unencumbered in a direction away from that first truss.

Alternatives to this approach might involve the combination use of working platforms and safety nets or, in situations where the potential fall distances are sufficient to allow their safe use, the installation of larger nets and/or restraint harnesses.

At all times, the Designers and Contractors should undertake proper Risk Assessments of the tasks in hand and draft appropriate method statements accordingly. Where the trussed rafter

designer/manufacture is also engaged to erect the roof structure then the method statement would be prepared by him and approved by the principal Contractor (who is responsible for the Health and Safety of all personnel, directly employed or otherwise, on the site). Some amendment or reassessment of the proposed working method may be necessary before the Principal Contractor allows the work to commence.

Erection Procedure

The builder should consider, in conjunction with the Building Designer, the erection procedures to be used and the provision of temporary bracing, rigging and any other specialised equipment required to erect the trusses safely and without damage, in accordance with the design requirements and having due regard to possible windy conditions.

Permanent bracing should be of minimum size 22 x 97mm free of major defects and fixed with two 3.35 x 65mm galvanised round wire nails at each cross-over.

The following procedure is suggested for most domestic size roofs.

1. - Mark the position of each truss along both wallplates.
2. - Erect the first truss (truss A in figure 94a) at the point which will coincide with the uppermost point of the diagonal brace F when it is installed later. Use the temporary raking braces B fixed to the rafter members and the wallplates to hold this truss in the correct position, straight and vertical. For clarity, only one raking brace is shown in the figure but they should be fixed to both rafter members and be of

sufficient length to maintain the truss in position, during the erection of the remaining trusses.

3. - Erect truss C and brace back to A with temporary battens D at suitable intervals along the rafter and ceiling tie members. Repeat this procedure until the last truss E is erected.
4. - Fix the permanent diagonal braces F ensuring that each top end is as high up the last trussed rafter A as is possible and that each bottom-end extends over the wallplate to which it should be fixed. For clarity, only one permanent brace is shown in the figure, but they should be installed on both sides of the roof.
5. - Fix the longitudinal members G, making sure that the ceiling ties are accurately spaced at the correct centres.
6. - Fix all remaining longitudinal, diagonal and chevron bracing required on the internal members of the trusses as specified.
7. - Additional trusses may be erected by temporarily 'bracing-off' the completed end.

Figure 94a

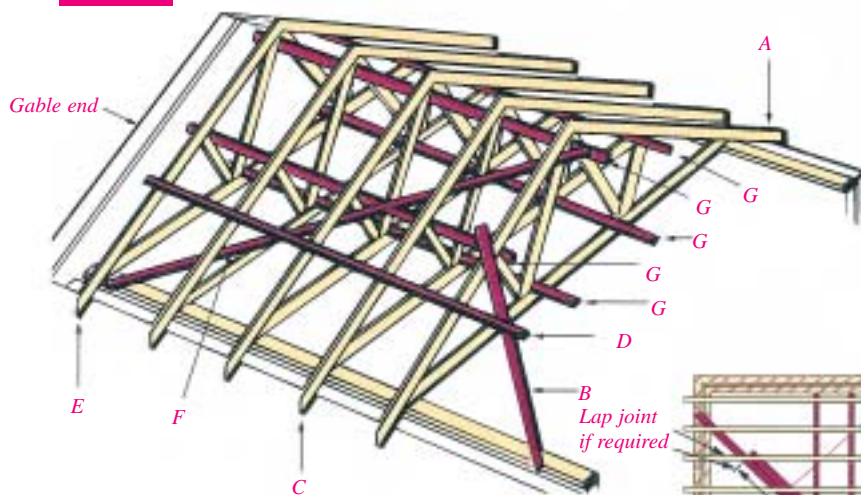
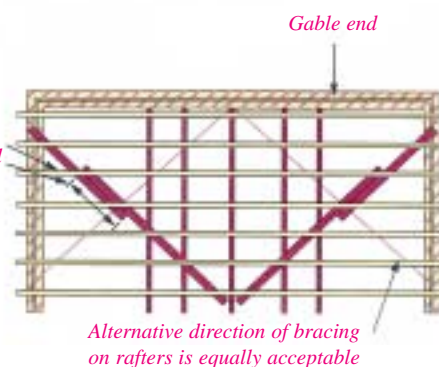

Figure 94b



Immediately prior to the fixing of the permanent bracing and the tiling battens or sarking, all trussed rafters should be checked for straightness and vertical alignment. Whilst every effort should be made to erect trusses as near vertical as possible, the maximum deviations from the vertical shown in the following table may be permitted.

Maximum deviation from vertical

Rise of truss (m)	1	2	3	4 or more
Deviation from vertical (mm)	10	15	20	25

After erection, a maximum bow of 10mm may be permitted in any trussed rafter provided that it is adequately secured in the complete roof to prevent the bow from increasing. For rafter members, this maximum bow is measured from a line between the apex and the eaves joint.

Risk Assessments and Method Statements

(This section is intended to give general guidance to Contractors regarding appropriate controls for assessing and documenting the risks associated with construction task).

Perhaps it is appropriate under this section to note that the undertaking of Risk Assessments and compilation of Method Statements (where appropriate) is the **LEGAL DUTY OF ALL CONTRACTORS** as it is for Designers under the Construction (Design and Management) Regulations 1994. Such Assessments are necessary to appraise hazards and their associated risks in order that these risks may be either minimised or controlled.

The responsibilities and obligations of Contractors are primarily laid down in the following Regulations:

Health and Safety at Work Act 1974

Construction (Design and Management) Regulations 1994

Management of Health and Safety at Work Regulations 1992

Provision and Use of Work Equipment Regulations 1992

Construction (Health, Safety and Welfare) Regulations 1996 - (CHSW Regulations 1996)
Manual Handling Operations 1992

Workplace (Health, Safety and Welfare) Regulations 1992

Examples of a typical Risk Assessment and supporting Method Statement are given on pages 76 and 77. These are presented to illustrate the difference between a Contractors Standard Health and Safety Policy which should include provision for all 'Standard' risks - as documented in the Contractors General Risk Assessment (which may simply be an amended sheet from the Company Health and Safety Policy Manual) and PPE/Manual Handling Risk Assessments and/or detailed Method Statements which are custom written to deal with specific, non-standard or particularly risky aspects of work.

Risk Assessments and Method Statements

Contractors general risk assessment for the erection and assembly of roof trusses

Under the Management of Health and Safety at Work Regulations 1992 contractors are required to undertake and record risk assessments for site specific tasks and locations of work. These Risk Assessments can be used to i) identify provision within tender/contract documents regarding matters

relating to Health and Safety, ii) check Health and Safety conditions on site, iii) developing safe system of work and Method Statements where required and iv) provide information on hazards to operatives/personnel at the place of work.

By way of an example which illustrates typical criteria for assessing the risks associated with a particular work task the following example assessment has been prepared:-

Project Title: <i>Housing Estate, Anywhere</i>		Document Reference No: <i>RA/Gen/OJA</i>	
Client: <i>J Bloggs + Co</i>		Date: <i>**/**/**</i>	
Description of Works: <i>General Roof Activities</i>		Author: <i>AJF</i>	
Hazards:	Risk Ratings		
(This list should also refer to those hazards identified in the roof Designers Risk Assessment and also those contained in the site Health and Safety Plan), e.g: Persons falling - Falling objects -	Without Controls	With Controls	
	<i>High</i>	<i>Low</i>	<i>Low</i>
	<i>Medium</i>		<i>Low</i>

Harm:
Significant injuries or fatalities without controls

Persons in Danger:
Roof operatives, other operatives in the vicinity, general public as passers by

Controls:
This section should typically include information relating to the design and use of the following:- Ladders, Scaffolds, Working Platforms, Storage Areas, Edge Protection and Barriers, Lifting Equipment, Disposal of waste, PPE, Warning Notices, Checking Procedures, Adverse weather, Plant Maintenance etc.

PPE:
Safety Helmets, Protective Footwear and Gloves should be worn

Additional Assessments Required?
Manual Handling (where appropriate) activities and PPE

Method Statement Required?
Yes, see method statement ref. MG/GEN/OJ

Can the Work Task be adequately controlled?
Yes

Specific Legislation and other Informative Guidance Documents:
CHSW Regs 1996: CDM Regs 1994: Manual Handling Regs 1992 etc

Information, Instruction and Training:
See Company Training Information - No operatives shall carry out any activity without proper training as noted therein

Emergency Procedures:
Display Procedure in site offices, Ensure personnel know how to raise alarm, provide Adequate First Aid Kit

Monitoring Procedures:
This shall be the responsibility of the Site Manager to organise and implement according to established procedure

Any other Items:
As appropriate

Signed:

Date:

Risk Assessments and Method Statements

Task Description: <i>Erection of Trussed Rafter Roof Structure using Manual handling Method Ref 01.</i>	Project Title: <i>Housing Development at Muddy Lane, Newtown, Smoke City</i>	Ref: _____ No: _____ Date: _____ Author: _____
---	--	---

**This Safe Working Method Statement has been prepared for the following work.
No other work than that referred to must be carried out.**

Location of Work Task: <i>House type A (South Facing only) on Muddy Lane</i>	Project Title: <i>Erection and Installation of trussed Rafter Roof Structure to House Type A</i>
--	--

Safe Working Method:

For additional reference regarding this method statement refer to Contractors sketch ref. ***/** as illustrated on page (?) of this site installation guide. At all times this method statement assumes that all appropriate design considerations have been incorporated and allowed for within the design and layout of the temporary working platforms. Additionally, it should be noted that this method statement refers only to those operations which have been designated as having a higher level of risk, for all matters associated with this operation reference shall be made and working practices adopted which comply with the Contractors general Risk Assessment for roof work.

Part 1:

1. Construct external perimeter scaffold as per detail in a manner to ensure sufficient manoeuvring space around loading platform. Locate vertical truss restraint standards at position to allow unobstructed lifting to eaves level working platform. All edge protection to both the eaves level and the loading level platforms must be constructed and fixed before any lifting operations take place. Similarly, erect internal working platforms at a level (typically) 300mm below ceiling tie level.

Under no circumstances whatsoever shall any edge protection be removed to facilitate these operations.

2. According to the recommendations of the Manual Handling Risk Assessment use x No. Personnel to manually lift individual trusses via the truss restraint standards to the eaves level working platform. Move trusses along the length of the roof to their final position (where they shall immediately be fixed by carpenters using temporary/permanent bracing - see part 2 of this method statement). NB. Girder trusses shall be raised as single component plies and then the ceiling tie members (min) bolted together according to the details provided by the truss manufacturer and in locations marked by him on the trusses; rafter and web members may be nailed according to further details provided by the truss manufacturer.

NB. Roof Bracing Details which will include sizes and location of Rafter and Chevron Bracing etc, shall be installed in accordance with the roof designers layout drawing.

Part 2:

3. When the first truss has been raised and located in its final position by the truss handling team, the carpenters shall immediately provide temporary diagonal restraints at a minimum of three locations to hold the truss vertical and so as to act as a rigid start point for the erection of the remainder of the trusses. This temporary restraint shall preferably be located outside of the roof structure i.e. Fixed to the external perimeter scaffold. The positioning of the temporary braces in this way will then allow unobstructed passage to the truss handling team as further trusses are raised and located in their final position.

NB. Wherever possible, Carpenters should use pre-nailed bracing members (accurately marked out to coincide with the truss centres) to ensure that truss erection progresses smoothly and quickly.

4. As soon as sufficient trusses have been temporarily positioned, the carpenters shall commence the fixing of internal permanent bracing to create fully stable sections of roof. Where necessary for carpenters to work at higher levels than the main internal working platform then either stepladders or temporary trestles shall be used between trusses constructed or positioned on the main platform. Under no circumstances shall operatives be allowed to climb within the temporarily braced roof structure.

5. As soon as permanently braced sections of roof have been completed, it shall be allowed for operatives to locate working platforms within the roof structure by positioning suitable boards directly on top of the ceiling ties. These platforms can then be used for the installation of services etc. Similarly, at this time it is appropriate to allow the removal of the external temporary props in order to allow any gable masonry construction to be commenced. Gable construction should not have been allowed to commence prior to this stage as it is the stability of the roof construction which provides restraint to the gable masonry construction.

NB. The dismantling of the internal working platform shall only be allowed to commence below completed areas of roof construction as such time when no work is being carried out overhead.

6. Further areas of roof construction (if appropriate) shall be carried out according to the identical principles outlined above.

Construction Check List

Job No: _____ Contractor: _____
 Site: _____ Block: _____
 Inspector: _____ Date: _____

OK **NOT OK**

	Yes	No
Trussed Rafters		
Correct quantity, positions and orientation	<input type="checkbox"/>	<input type="checkbox"/>
Centres not greater than specified	<input type="checkbox"/>	<input type="checkbox"/>
Verticality and bow after erection within code limits	<input type="checkbox"/>	<input type="checkbox"/>
No damage or unauthorised modifications	<input type="checkbox"/>	<input type="checkbox"/>
Girders/Multiple trusses connected together in accordance with specification	<input type="checkbox"/>	<input type="checkbox"/>
Properly seated on wallplates, hangers, etc.	<input type="checkbox"/>	<input type="checkbox"/>
Bracing correct size and in correct position	<input type="checkbox"/>	<input type="checkbox"/>
Bracing connected to each truss as specified	<input type="checkbox"/>	<input type="checkbox"/>
Bracing laps extended over a minimum of 2 trusses	<input type="checkbox"/>	<input type="checkbox"/>
Bracing of truss rafter compression members are installed as specified	<input type="checkbox"/>	<input type="checkbox"/>
Valley set is correctly set out and braced as specified	<input type="checkbox"/>	<input type="checkbox"/>
Valley set is supported on bevelled bottom chord or supported on fillet	<input type="checkbox"/>	<input type="checkbox"/>
Loose Timbers		
Correct sizes, position and grade	<input type="checkbox"/>	<input type="checkbox"/>
Centres not greater than specified	<input type="checkbox"/>	<input type="checkbox"/>
Birdsmouth, joints, scarfs etc., accurately and correctly made	<input type="checkbox"/>	<input type="checkbox"/>
Properly seated on wallplates, hangers, etc.	<input type="checkbox"/>	<input type="checkbox"/>
Fixings are to specification	<input type="checkbox"/>	<input type="checkbox"/>
Structural Metalwork		
Truss clips, framing anchors and other vertical restraints present and fully nailed	<input type="checkbox"/>	<input type="checkbox"/>
Hangers correct to specification and fixed as specified	<input type="checkbox"/>	<input type="checkbox"/>
Gable restraint straps present and correctly fixed including pack between members	<input type="checkbox"/>	<input type="checkbox"/>
Tank Platform		
Correctly positioned and constructed as specified	<input type="checkbox"/>	<input type="checkbox"/>
Loads applied to trusses as allowed for in design	<input type="checkbox"/>	<input type="checkbox"/>
Special Items		
Services in position specified and do not clash with webs	<input type="checkbox"/>	<input type="checkbox"/>
Roof ventilated as specified	<input type="checkbox"/>	<input type="checkbox"/>
Trap hatch formed to specification	<input type="checkbox"/>	<input type="checkbox"/>
Sarking if applicable, is to specification	<input type="checkbox"/>	<input type="checkbox"/>
Tiles fixed are correct weight as specified in design	<input type="checkbox"/>	<input type="checkbox"/>

Comments

Nailing and Bolting

Scab Members

Rafter sizes in raised tie trusses often need to be increased, since the entire weight of the roof structure is supported on the extended rafters resulting in large bending forces. Even then, timber scabs or reinforcing members are often necessary and it is essential that they are correctly fitted whenever specified. Scabs may be required on one or both faces of the extended rafter and may also be required on multiple trusses. The truss manufacturer may fix the scabs in the factory prior to delivery or may provide the scabs loose, with a fixing detail to allow them to be secured on site. Scabs on multiple trusses will invariably require bolting - large plate washers should be used with all bolts.

Figure 95

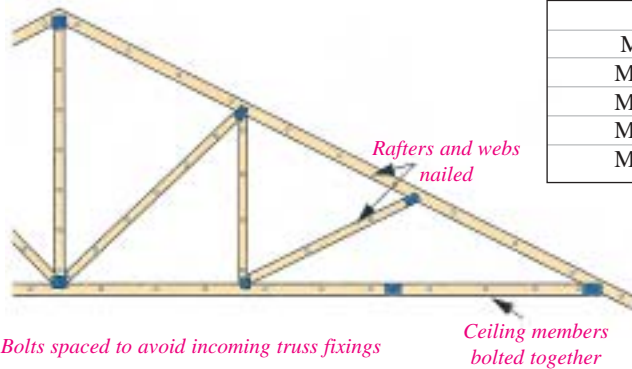

Typical Scab Nailing Positions

Scabs may be fixed by the manufacturer or on site using a nailing or bolting details provided by the manufacturer.

Figure 96

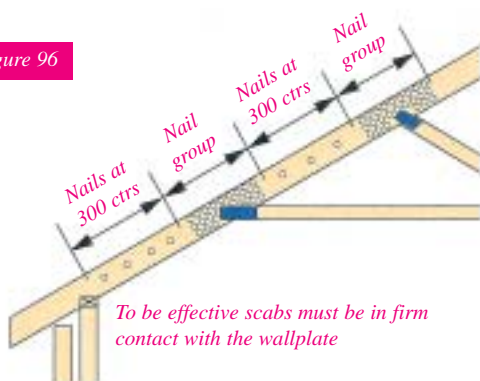

Girder Trusses

Girder trusses are designed to carry more load than that from the standard trussed rafter spacing. They consist of two or more trussed rafters fastened together. Typically, girder trusses carry other trussed rafters or infill timbers on shoes attached to the ceiling tie of the girder.

Girders are fastened together by nails or bolts. When fastened together on site, bolts must be used for at least the ceiling tie members, in positions marked by the truss manufacturer. In all cases, the nails or bolt must be positioned strictly in accordance with the manufacturer's instructions.

See TRA Information Sheet 9804 'Girder Trusses (Principal Trusses) Definitions and Connecting Together On Site'.

Washers must be used under the head and nut of each bolt.

Bolt Diameter	Washer Size	
	Diameter	Thickness
M8	24mm	2mm
M12	36mm	3mm
M16	48mm	4mm
M20	60mm	5mm
M24	72mm	6mm

Figure 97

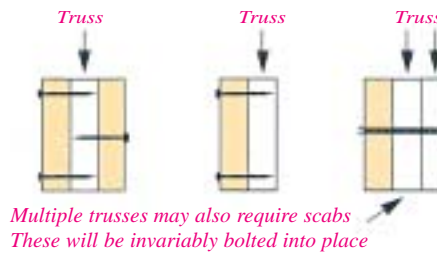

Nails and bolts should either be inherently corrosion resistant or protected by a corrosion resistant coating.

Attic Frames 2 & 3 Part Construction

All the trusses (or frames) are generally of two basic types depending on how they are supported.

Type 1:

(Figure 98a) is characterised by a load-bearing support at or near mid-span and as a result generally has heavy joists propping relatively light rafters. The truss may need to be supplied in kit form for completion on site if it is too high for fabrication or

transportation. The kit form, while requiring some site fabrication, does make for straightforward erection as the floor joists can be installed first, providing a safe, rigid working platform.

Figure 98a



Completed nailed site connections

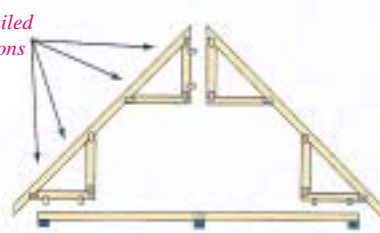

Type 2:

(Figure 98b) is free spanning between wallplates and as a result the floor is suspended from the rafters which consequently are relatively heavy and often as heavy as the floor joists. The associated kit form is usually different to that for type 1 in order to facilitate erection and to ensure that the more important joints are made under factory controlled

conditions. However, substantial connections, often employing MiTek field splice plates, fully nailed or bolts, have to be made between the capping and base components, handling and erection of these heavy units needs to be carefully supervised.

Figure 98b



Field splice plate, bolted or nailed site connections

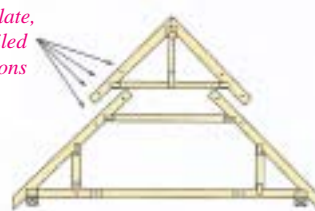
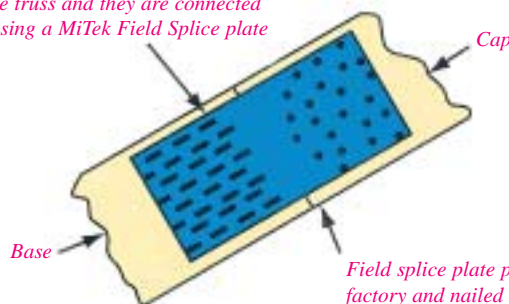

Figure 98c

Often the cap truss sits in the same plane as the base truss and they are connected together using a MiTek Field Splice plate



Field splice plate pressed into one part in factory and nailed in other part on site

Attic Frames - Bracing

Permanent bracing is required in all roofs for four reasons:

- a. to maintain rafter stability
- b. to prevent dominoing
- c. to form diaphragms to transmit wind loads to shear walls
- d. to maintain the stability of internal compression members

By far the most serious matter which arises in roof surgeries is rafter (roof) instability, arising from lack of suitable bracing.

Permanent bracing is the responsibility of the Building Designer. The advice and recommendations given here are given in the interests of good building practice and are not to imply responsibility accepted by MiTek. They should be considered as the necessary minimum.

Figure 99a

2 No 3.35 x 65mm galvanised nails at all cross overs

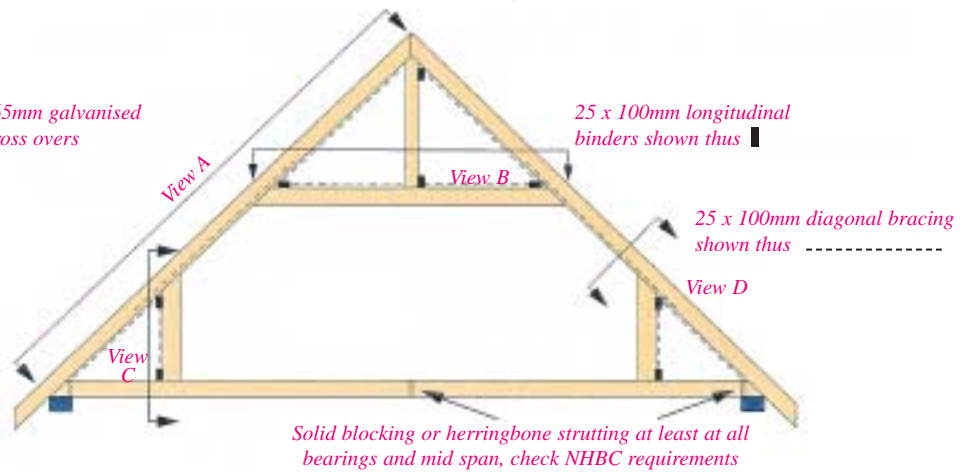
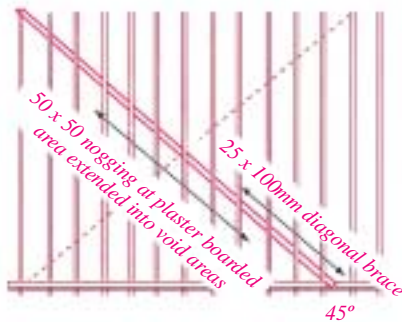
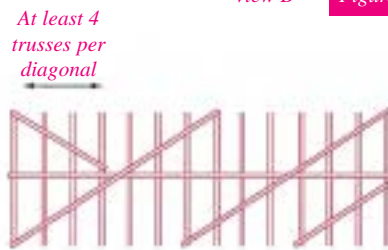

Figure 99b View A



Note: Bracing shown must be installed both sides of ridge and repeat at intervals (with a minimum of two) along roof. Alternate rising to left and to right. Where the roof is short the second line of bracing may cross as shown by the broken line.

View B Figure 99c



At least 4 trusses per diagonal
Two diagonals each end. One diagonal alternatively each side of centre line elsewhere

Figure 99e View D

Alternative to one line of diagonal rafter bracing

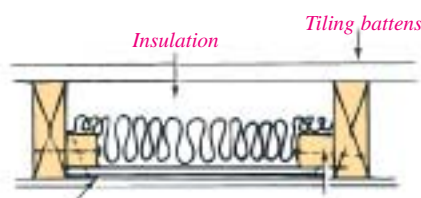

Tight fitting 12mm plywood fixed with 60mm nails at 250mm centres

50 x 50 ledgers fixed with 100mm nails at 250mm centres

View C Figure 99d



At least 4 trusses per diagonal
Diagonals repeat continuously along building, they may rise to left or right or vary

The structural action of diagonal bracing is the completion of triangulation in various planes, in order to form rigid diaphragms. For example, in the plane of the rafters this is provided by rafters, tiling battens and the bracing members.

The effectiveness of the noggined parts of the diagonals in figure 99b might be open to question, as it is very dependent on the quality of installation. Suitable alternatives are plywood diaphragms (figure 99e).

Attic Frames - Environment

Fire

Room-in-the-roof constructions is in an unusual position in regard to fire regulations. The floor, of course, must have the usual, minimum modified half-hour endurance. However, additional precautions should be taken to prevent spread-of-fire into the roof cavities and to ensure the integrity of the connectors for the full half hour.

Alternative solutions are:

a. Continue the floor boarding into the side triangles sealing it to the wall plate as shown (figure 100a) and protect the connectors with 12.7mm plasterboard cover plates.

b. Install under the floor joists a ceiling lining capable of providing full or almost full protection eg:

1. 12.7mm 'Fireline' plasterboard
2. Normal 12.7mm plasterboard plus a 5mm plaster skim coat
3. 12.7mm plus 9.5mm plasterboard with staggered joints

If compliance with the ventilation requirements of the Building Regulations is to be effected through eaves vents, these should be made impassable to fire.

Figure 100a

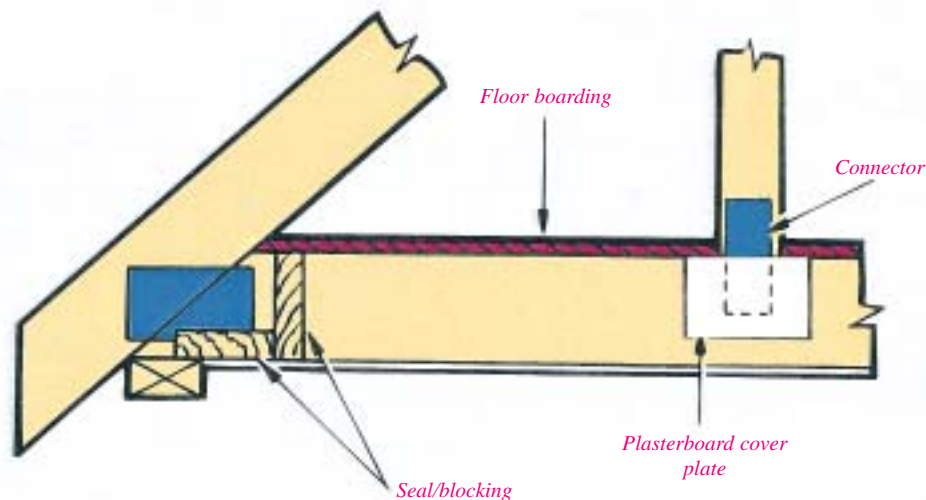

Insulation and Ventilation

Thought should be given to the type and location at an early stage, as this might well determine the depth of rafter to be adopted.

A cool regime (figure 100b) required ventilation to control condensation. An airgap of not less than 50mm should be provided between the top of the insulation and the underside of the roof covering.

With a 100mm mineral wool quilt the smallest standard finished size of timber to provide the necessary depth is 147mm.

Warm roof regimes (figure 100c) need the same ventilation with, in addition, ridge vents providing at least a 5mm minimum continuous gap.

Figure 100b

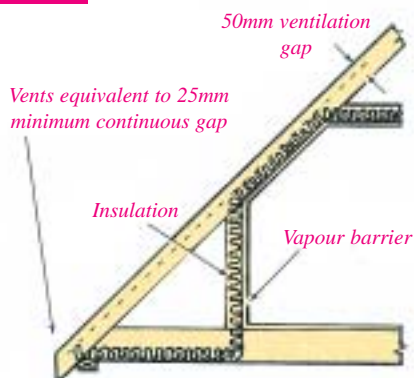
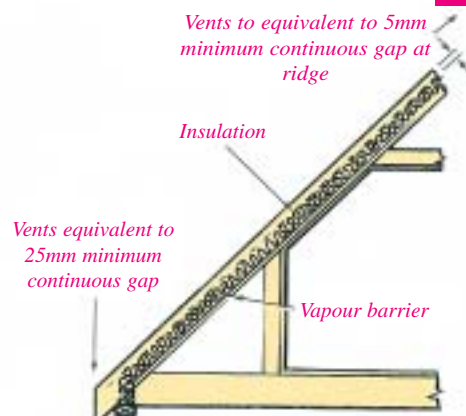

Figure 100c



General Construction details

In general, it is preferable to use one of the proprietary types of fixings, 'A', between the ends of the trussed rafters and the wall plates or bearings as shown in figure 103.

Where proprietary fixings are not used, the minimum fixing at each bearing position should consist of two 4.5 x 100mm long galvanised round wire nails, which are skew nailed from each side of the trussed rafter into the wallplate or bearing. Where nailing through the punched metal plate cannot be avoided, the nails should be driven through the holes in the fasteners. This method of fixing should not be used with stainless steel metal plate fasteners or where the workmanship on site is not of a sufficiently high standard to ensure that the fasteners, joints, timber members and bearings will not be damaged by careless positioning or overdriving of nails.

Figure 101

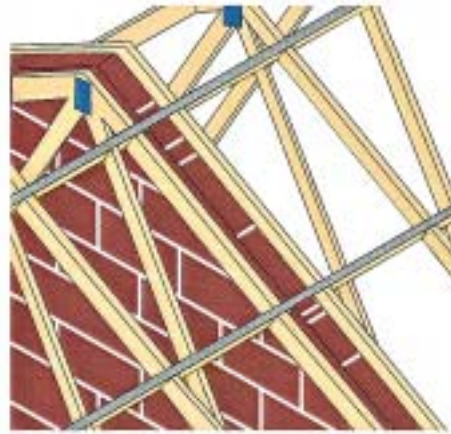

The Building Designer should ensure that, when required, adequate holding down fixings, 'C', are specified for both the trussed rafter and the wall plates or bearings.

Figure 102 Restraint strap at ceiling level



Noggings to be provided and set horizontal unless the strap has a twist to line it up with the roof slope

Strap fixed to solid noggings with a minimum of four fixings of which at least one is to be in the third joist/rafter or in a noggin beyond the third joist/rafter

Figure 105 Restraint strap at rafter level

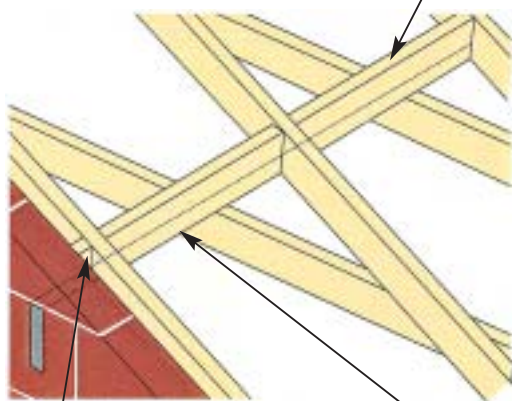

Packing piece between inner leaf and first rafter

Strap bedded under a cut block

Figure 103

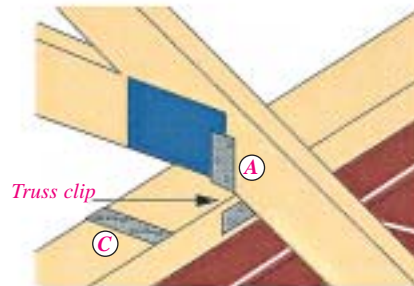

Internal non-loadbearing walls

It is advisable to erect non-loadbearing walls after the tiling has been completed thus allowing deflection to take place under the dead load, thereby reducing the risk of cracking appearing in the ceiling finishes. If partitions are of brick or block, then as an alternative the final course may be omitted until tiling has been completed

Figure 104

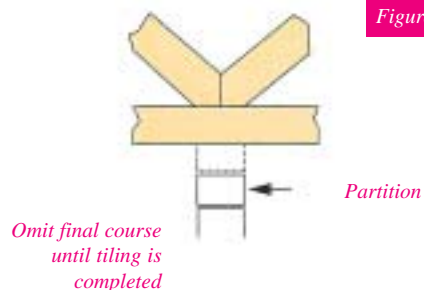

Omit final course until tiling is completed

Partition

General Construction details

Hogging over party walls

Party walls should be stopped 25mm below the tops of rafters. During construction layers of non-combustible compressible fill such as 50mm mineral wool should be pressed onto the locations shown to provide a fire stop as figure 106.

Continuity across party walls

If the tiling battens are required to be discontinued over a party wall, then lateral restraint must be provided in addition to that required to transfer longitudinal bracing forces.

This should consist of straps adequately protected against corrosion. These straps should be spaced at not more than 1.5m centres and be fixed to two rafter members and noggins on each side of the party wall by 3.35mm diameter nails with a minimum penetration into the timber of 32mm.

Hipboards

Fixing over flat-top girder

Where hipboards pass over and are supported on flat top girder trusses, the hipboard must be notched in order to achieve the correct height for the hipboard and to provide horizontal bearing. The flying rafter of the truss may need to be trimmed but in no circumstances should the flat chord or the rafter below the joint be cut. In most cases the hipboard is supplied in two parts which can be joined over the flat top truss. One method of providing the necessary fixing is illustrated in figure 108.

Figure 109

50 x 150 ledger nailed to truss using 3.75 x 90mm galvanised round wire nails

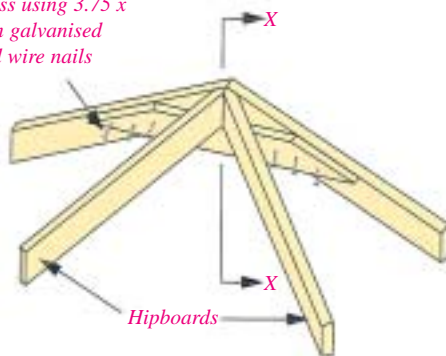

Figure 106

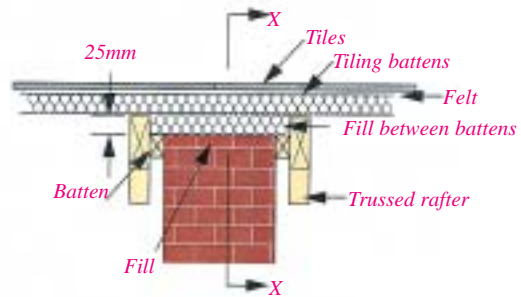

Figure 107

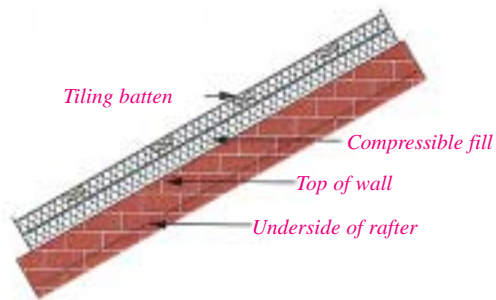
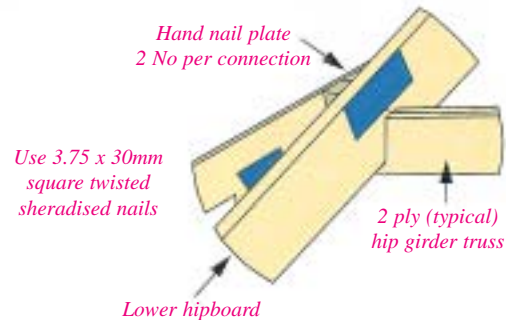
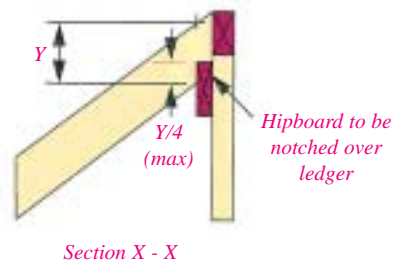

Figure 108



Hipboard to be notched over girder truss and butted together over centre of girder.



Builders Metal Work

Metalwork for timber-to-timber and truss to masonry connections are always required at some point in a roof structure.

MiTek Industries Limited are leading suppliers of all fixings necessary for the erection of trussed rafter roofs.

A separate catalogue is available detailing the full range of fixings we stock and supply, but detailed below are just some of the products available.

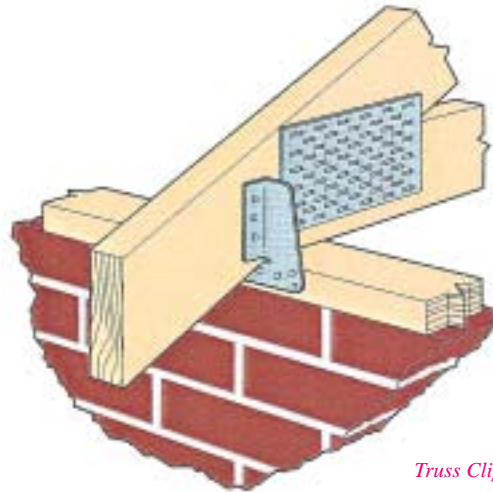

Truss Clip

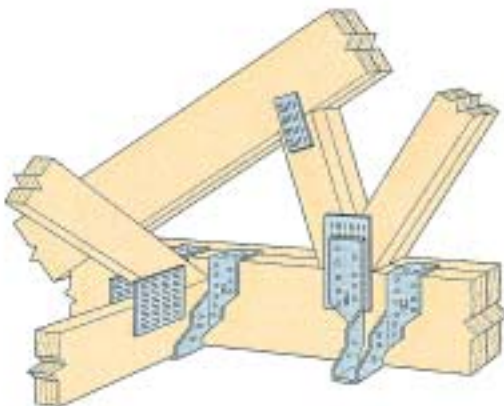

Truss Hanger

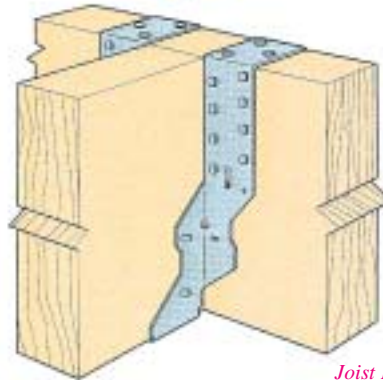

Joist Hanger

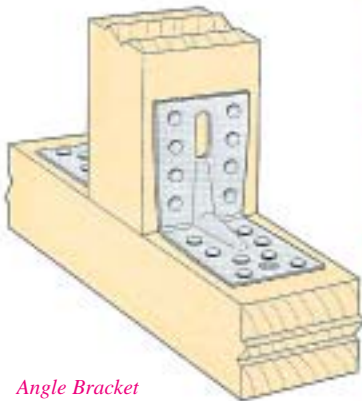

Angle Bracket

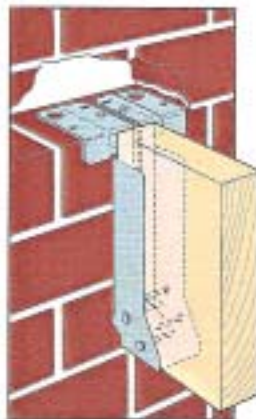

Masonry Hanger

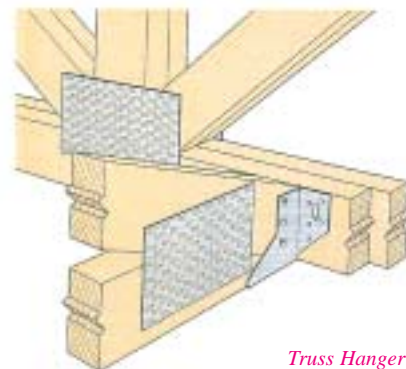

Truss Hanger



Lateral Restraint Strap

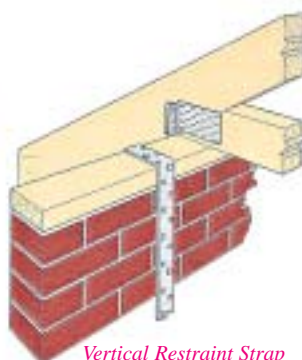

Vertical Restraint Strap

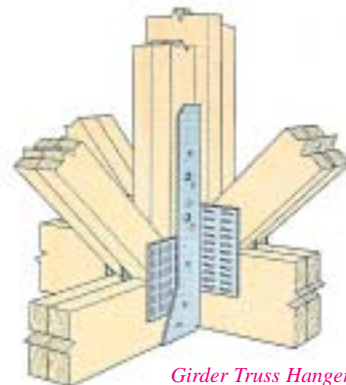

Girder Truss Hanger

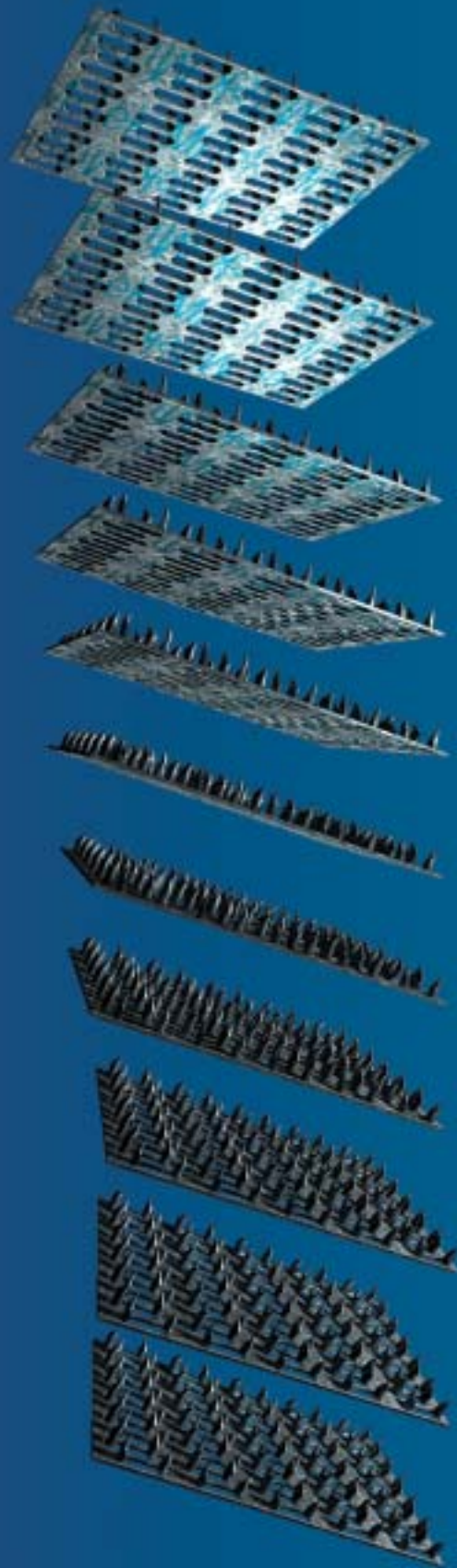

MiTek Industries Limited
MiTek House
Grazebrook Industrial Park
Peartree Lane
Dudley
West Midlands DY2 0XW

Tel: 01384 451400
Fax: 01384 451411

